

**Shodex**

**Capture the Essence**

HPLC Columns

2025-2026



# Shodex

We provide a wide range of products to meet your analytical needs, from pretreatment and separation columns to calibration standards for size exclusion chromatography. Please visit the Shodex website to see detailed information about our products and their uses with abundant application data.

**Shodex website**

**<https://www.shodex.com/>**



## **[Caution]**

1. Please read the operation manual carefully before the use.
2. For improvement purposes, some specifications are subject to change without notice.
3. Figures and descriptions in this catalog are provided to help you select appropriate columns. They do not guarantee nor warrant the suitability for your applications.
4. It is essential to take normal precautions when handling reagents and other chemical products even if the safety information is not included in the operation manual.
5. Products described in this catalog are not intended for medical use or medical applications including medical diagnosis.

# Contents

<b>Column Selection</b>	Types of Columns, Base Materials, Functional Groups and Ligands	2	
	HPLC Separation Modes	3	
	Column Selection (Category)	4	
	Precautions for Polar Polymer Analysis	11	
<b>HPLC Columns</b>	Polymer-based Reversed Phase Chromatography Columns (ODP2 HP)	12	
	Polymer-based Reversed Phase Chromatography Columns (Asahipak)	14	
	Polymer-based Reversed Phase Chromatography Columns (RSpak)	16	
	Reversed Phase Chromatography Hydrophilic Interaction Chromatography (HILIC)	Polymer-based Hydrophilic Interaction Chromatography (HILIC) Columns (HILICpak)	18
		Polymer-based Hydrophilic Interaction Chromatography (HILIC) Columns (Asahipak)	22
		Silica-based Reversed Phase Chromatography Columns (ODS Columns)	24
		Silica-based Reversed Phase Chromatography Columns (ODS Columns for UHPLC)	24
	Ligand Exchange Chromatography	Ligand Exchange Chromatography Columns	26
	Ion Exclusion Chromatography	Ion Exclusion Chromatography Columns	30
	Ion Chromatography	Ion Chromatography Columns (Anion Analysis)	32
Ion Chromatography Columns (Cation Analysis)		33	
Size Exclusion Chromatography (SEC)	Aqueous SEC (GFC) Columns: Silica-based	36	
	Aqueous SEC (GFC) Columns: Polymer-based	40	
	Multimode Columns	44	
	Aqueous-Organic SEC Columns	46	
	Organic SEC (GPC) Columns: General Analysis (THF)	48	
	Organic SEC (GPC) Columns: Solvent-Peak Separation	48	
	Organic SEC (GPC) Columns: General Analysis (DMF)	50	
	Organic SEC (GPC) Columns: High Performance Analysis	52	
	Organic SEC (GPC) Columns: Ultra-Rapid Analysis	54	
	Organic SEC (GPC) Columns: Linear Calibration Type	56	
	Organic SEC (GPC) Column: Rapid Preparation	58	
	Organic SEC (GPC) Columns: Preparative	59	
	Solvent Replacement Applicability of Organic SEC (GPC) Columns	60	
	<b>Calibration Standards</b>	Calibration Standards for SEC	61
Ion Exchange Chromatography	Anion Exchange Chromatography Columns	62	
	Cation Exchange Chromatography Columns	62	
Chiral Separation	Chiral Separation Column	64	
For Bionanoproduct Analysis and Preparative Use	Aqueous SEC (GFC) Columns: Polymer-based	64	
<b>Sample Pretreatment Columns</b>	Pretreatment Column for Column Switching Method	64	
	GPC Clean-up Columns	64	
<b>Information</b>	Solvent Replacement Method for Organic SEC (GPC) Columns	66	
	Column Cleaning	68	
	General Precautions for Column Handling	69	
	Troubleshooting	70	
	USP-NF Column List	72	
<b>Index</b>	Index by Product Name	73	
	Index by Product Code	74	
<b>Announcement</b>	Shodex Support	76	
	Announcement of Paperless Product Operation Manuals and Certificate of Analysis	77	

# Types of Columns, Base Materials, Functional Groups and Ligands

Separation Type		Product Name	Base Material	Functional Group, Ligand	Page
Reversed Phase & HILIC (Polymer-based)		ODP2 HP	Polyhydroxymethacrylate	—	12
	Asahipak	ODP-50, ODP-90 20F	Polyvinyl alcohol	Octadecyl	14
	Asahipak	C4P-50 4D	Polyvinyl alcohol	Butyl	14
	RSpak	DS-613, DS-413	Styrene divinylbenzene copolymer	—	16
	RSpak	DE-613, DE-413, DE-213	Polymethacrylate	—	16
	RSpak	DM-614	Polyhydroxymethacrylate	—	16
	RSpak	NN-814	Polyhydroxymethacrylate	Sulfo	16
	RSpak	JJ-50 2D	Polyvinyl alcohol	Quaternary ammonium	16
	HILICpak	VG-25, VG-50	Polyvinyl alcohol	Amino	18
	HILICpak	VT-50 2D	Polyvinyl alcohol	Quaternary ammonium	18
	HILICpak	VC-50 2D	Polyvinyl alcohol	Carboxyl	18
	HILICpak	VN-50	Polyvinyl alcohol	Diol	19
	Asahipak	NH2P-50, NH2P-40, NH2P-90 20F	Polyvinyl alcohol	Amino	22
	Reversed Phase (Silica-based)	Silica	C18M	Silica	Octadecyl
		C18U	Organic/inorganic hybrid silica	Octadecyl	24
Ligand Exchange	SUGAR	SC1011, SC1211	Styrene divinylbenzene copolymer	Sulfo (Ca <sup>2+</sup> )	26
	SUGAR	SP0810	Styrene divinylbenzene copolymer	Sulfo (Pb <sup>2+</sup> )	26
	SUGAR	KS-800	Styrene divinylbenzene copolymer	Sulfo (Na <sup>+</sup> )	26
	RSpak	DC-613	Styrene divinylbenzene copolymer	Sulfo (Na <sup>+</sup> )	26
	SUGAR	SZ5532	Styrene divinylbenzene copolymer	Sulfo (Zn <sup>2+</sup> )	26
	EP	SC1011-7F	Styrene divinylbenzene copolymer	Sulfo (Ca <sup>2+</sup> )	27
	USPpak	MN-431	Styrene divinylbenzene copolymer	Sulfo (Ca <sup>2+</sup> )	27
Ion Exclusion	SUGAR	SH1011, SH1821	Styrene divinylbenzene copolymer	Sulfo	30
	RSpak	KC-811	Styrene divinylbenzene copolymer	Sulfo	30
Ion Chromatography	IC	NI-424, I-524A	Polyhydroxymethacrylate	Quaternary ammonium	32
	IC	SI-90, SI-50, SI-52, SI-35, SI-36, SI-37	Polyvinyl alcohol	Quaternary ammonium	32, 33
	IC	YS-50	Polyvinyl alcohol	Carboxyl	33
	IC	YK-421	Silica	Carboxyl	33
Aqueous SEC (GFC)	PROTEIN	KW-800	Silica	Hydrophilic polymer	36
		KW400	Silica	Hydrophilic polymer	36
	PROTEIN	LW-803, LW-403 4D	Silica	Hydrophilic polymer	37
	OHpak	SB-800 HQ	Polyhydroxymethacrylate	—	40
	OHpak	SB-2000	Polyhydroxymethacrylate	—	40
	OHpak	LB-800	Polyhydroxymethacrylate	—	41
Multimode	Asahipak	GS-220 HQ, GS-320 HQ, GS-220 20G, GS-320 20G	Polyvinyl alcohol	—	44
Aqueous-Organic SEC	Asahipak	GF-210 HQ, GF-310 HQ, GF-510 HQ, GF-7M HQ, GS-310 20G, GS-510 20G	Polyvinyl alcohol	—	46
	MSPak	GF-310 4D			
Organic SEC (GPC)	GPC	KF-800, KD-800, KF-400HQ, HK-400, LF, FP-2002, KF-2000, K-2000, H-2000, KF-5000, K-5000	Styrene divinylbenzene copolymer	—	48 - 59
Ion Exchange	IEC	QA-825	Polyhydroxymethacrylate	Quaternary ammonium	62
	IEC	DEAE-825	Polyhydroxymethacrylate	Diethylaminoethyl	62
	Asahipak	ES-502N 7C	Polyvinyl alcohol	Diethylaminoethyl	62
	IEC	SP-825	Polyhydroxymethacrylate	Sulfopropyl	62
	IEC	SP-FT 4A	Polyhydroxymethacrylate	Sulfopropyl	62
	IEC	CM-825	Polyhydroxymethacrylate	Carboxymethyl	62
	Asahipak	ES-502C 7C	Polyvinyl alcohol	Carboxymethyl	62
	CXpak	P-421S	Styrene divinylbenzene copolymer	Sulfo (Na <sup>+</sup> )	62
Chiral Separation	ORpak	CDBS-453	Silica	β-Cyclodextrin derivative	64
Bionanoprotect SEC		UB-50, UB-100	Polyhydroxymethacrylate	—	64
Column Switching Pretreatment	MSPak	GF-4A	Polyvinyl alcohol	—	64
GPC Clean-up	CLNpak	EV	Styrene divinylbenzene copolymer	—	64



# HPLC Separation Modes

Liquid chromatography (LC) uses liquid as mobile phase (eluent). It is an analytical method that separates a mixture of compounds based on their physical and chemical differences. High performance liquid chromatography (HPLC) is a method that introduces the mobile phase under high-pressure conditions resulting in rapid and high-performance separations. The various interactions between the analyte, stationary phase (packing material), and mobile phase are the key factors for the separation. A wide variety of separation modes can be achieved by using particular combinations of stationary and mobile phases.

Separation Mode	Characteristics
Reversed Phase Chromatography (RPC)	<ul style="list-style-type: none"> <li>Separation is based on the partition equilibrium between stationary phase and mobile phase.</li> <li>The polarity of the stationary phase is lower than that of the mobile phase.</li> <li>Typically the mobile phase contains a mixture of organic solvents (methanol, acetonitrile, or THF) and aqueous solvents (water or buffer).</li> <li>Use of lower polarity mobile phases fasten the elution.</li> </ul>
Hydrophilic Interaction Chromatography (HILIC)	<ul style="list-style-type: none"> <li>Separation is based on hydrophilic interaction.</li> <li>A high polarity stationary phase is used.</li> <li>Typically the mobile phase contains a mixture of organic solvents such as acetonitrile and aqueous solvents (water or buffer).</li> <li>Using the higher polarity mobile phase causes a faster elution.</li> <li>Applicable for the analysis of high polar substances.</li> </ul>
Normal Phase Chromatography (NPC)	<ul style="list-style-type: none"> <li>Separation is based on the partition equilibrium between the stationary phase and the mobile phase.</li> <li>The polarity of the stationary phase is higher than that of the mobile phase.</li> <li>Typically the mobile phase contains a mixture of organic solvents with different polarities such as hexane and isopropanol.</li> <li>Using the higher polarity mobile phase causes a faster elution.</li> </ul>
Ligand Exchange Chromatography (LEX)	<ul style="list-style-type: none"> <li>Separation is based on differences in analytes' coordination complex.</li> <li>Stationary phase modified with metal sulfonate complex ion.</li> <li>Works in combination with size exclusion or HILIC modes.</li> </ul>
Ion Exclusion Chromatography (IEX)	<ul style="list-style-type: none"> <li>Separation is based on electrostatic interaction (repulsion) between the ion exchanger and ionic solutes.</li> <li>Dissociated ionic molecules elute faster than non-dissociated forms.</li> <li>Used mainly for the analysis of organic acids.</li> </ul>
Ion Chromatography (IC)	<ul style="list-style-type: none"> <li>Separation is based on electrostatic interaction (bonding) between the ion exchanger and ionic solutes.</li> <li>Electrical conductivity detector can be used with a mobile phase with low-salt concentration.</li> <li>Used mainly for the analysis of inorganic compounds.</li> </ul>
Size Exclusion Chromatography (SEC)	<ul style="list-style-type: none"> <li>Network or pores on the surface of the packing material works as molecular sieve to separate molecules based on their sizes.</li> <li>To separate molecules solely based on their sizes, it requires an analytical condition without any compounds and packing gel interaction.</li> <li>The bigger the molecule size, the faster the elution sequence.</li> <li>Used for molecular weight or molecular distribution determination of macromolecules and qualification of oligomers.</li> </ul>
Ion Exchange Chromatography (IEC)	<ul style="list-style-type: none"> <li>Separation is based on electrostatic interactions between the ion exchanger and ionic solutes.</li> <li>The mobile phase of choice should have a sufficient buffering capacity at the pH that produces the largest charge differences between the analyte of interest.</li> <li>The elution position is optimized by varying the pH, salt concentration, and/or ionic strength of the mobile phase.</li> </ul>
Hydrophobic Interaction Chromatography (HIC)	<ul style="list-style-type: none"> <li>Separation is based on hydrophobic interaction.</li> <li>Hydrophobic functional group is modified on the stationary phase.</li> <li>Adsorption of analytes generally occurs at a high salt concentration and they are released by lowering the salt concentration.</li> <li>Used mainly for the analysis of proteins.</li> </ul>
Affinity Chromatography (AFC)	<ul style="list-style-type: none"> <li>Separation is based on adsorption of the analyte to the specific biologically derived ligand pair.</li> <li>Highly selective.</li> <li>A buffer solution with the appropriate pH and ionic strength is selected based on the type of ligand, analytes, and their interaction.</li> <li>Used mainly for the purification and concentration of biologically active substances.</li> </ul>
Chiral Separation Chromatography (CS)	<ul style="list-style-type: none"> <li>Separation of optical isomers using chiral selectors.</li> <li>Highly selective.</li> </ul>
Multimode Chromatography	<ul style="list-style-type: none"> <li>Separation is based on the combination of different modes.</li> </ul>

# Column Selection (Proteins, Peptides, and Amino Acids)

	Separation Mode	Figure	Column	Page
Proteins Peptides	SEC		KW-802.5, KW402.5-4F	36
			LW-803, LW-403 4D	37
			KW-803, KW403-4F	36
			KW-804, KW404-4F	36
			KW405-4F	36
	Reversed phase		DE series	16
			ODP-50 series	14
			C4P-50 4D	14
	HILIC		VC-50 2D	18
			NH2P series	22
	Ion exchange		QA-825	62
			DEAE-825	62
			ES-502N 7C	62
			SP-825, SP-FT 4A	62
			CM-825	62
ES-502C 7C			62	
Multimode		GS-220 HQ	44	
		GS-320 HQ	44	
Amino acids	Ion exchange		NN-814	16
			YS-50	33
			P-421S	62
	Reversed phase		ODP-50 series	14
			VC-50 2D	18
	HILIC		VG series	18
			NH2P series	22

## Column Selection (Nucleic Acids)

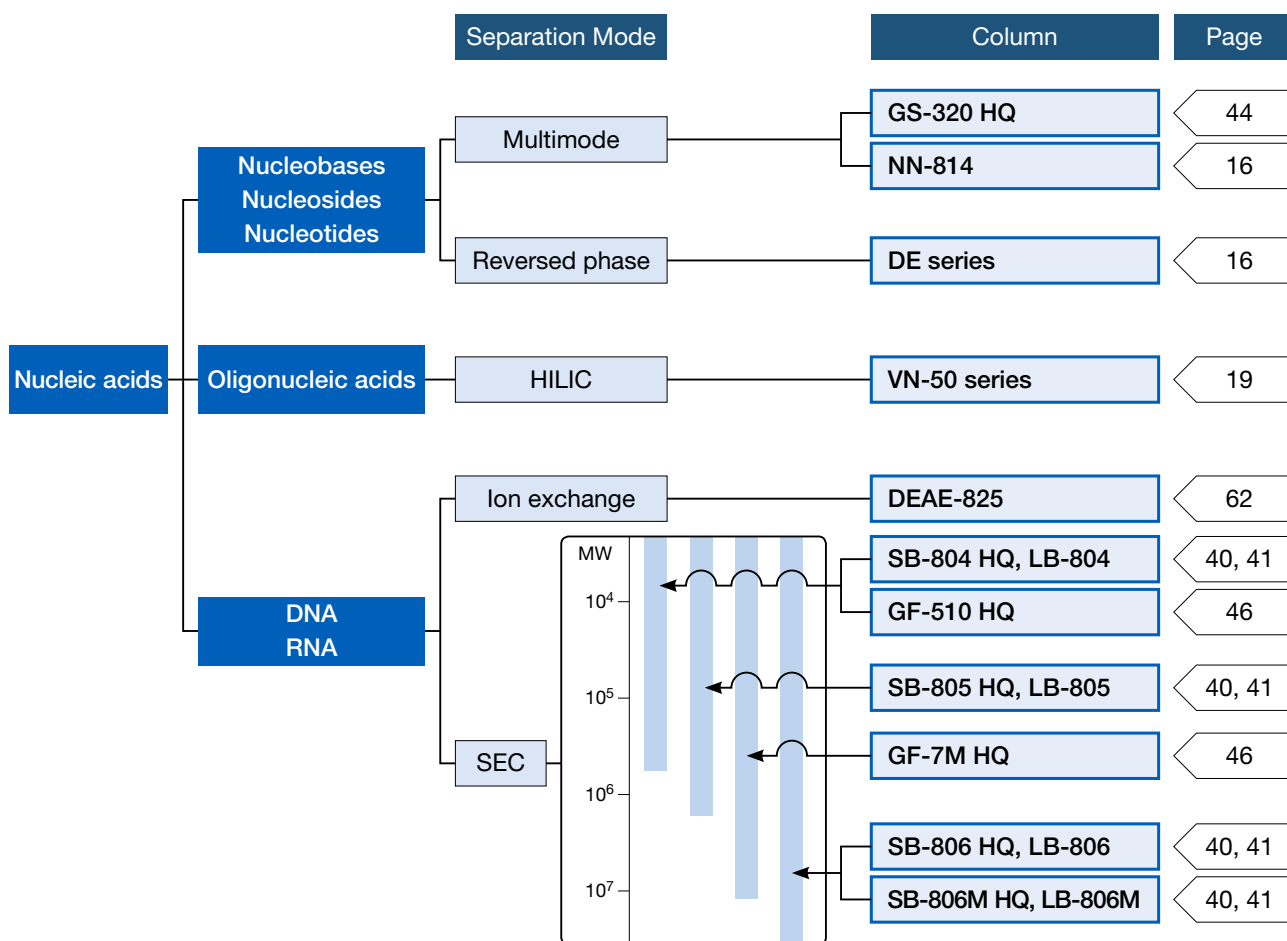

## Column Selection (Organic Acids)

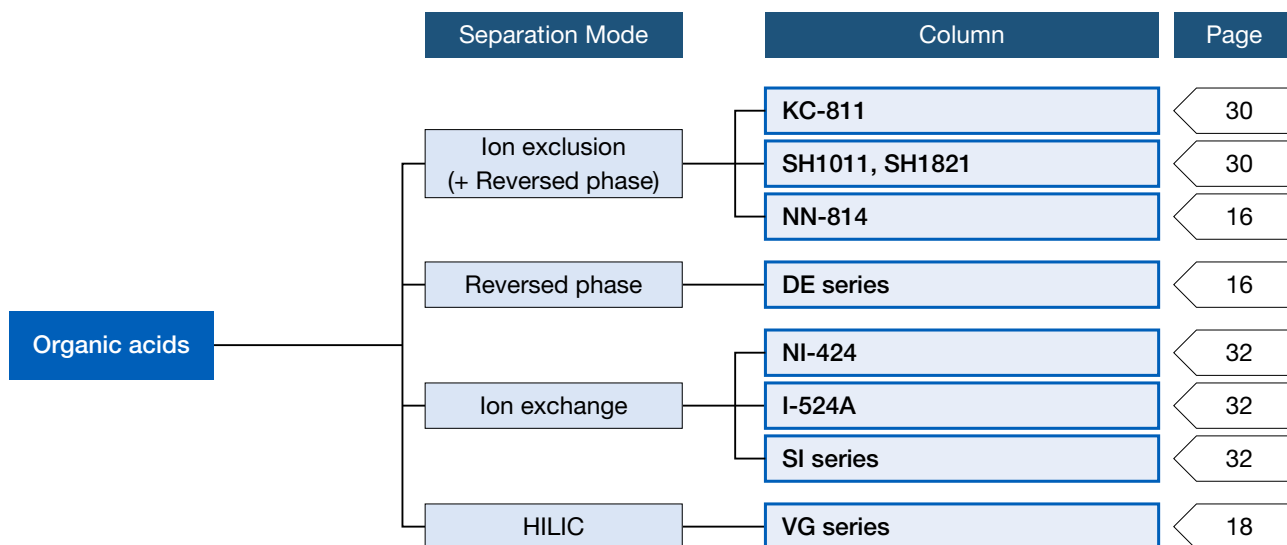

# Column Selection (Saccharides)

	Separation Mode	Column	Page
Mono-, di-saccharides, and sugar alcohols Saccharides and sugar alcohols	Ligand exchange + SEC	SP0810 (Pb <sup>2+</sup> )	26
		SC1011 (Ca <sup>2+</sup> )	26
		KS-801 (Na <sup>+</sup> )	26
	Ligand exchange + HILIC	SZ5532 (Zn <sup>2+</sup> )	26
		DC-613 (Na <sup>+</sup> )	26
	HILIC	VG series	18
		NH2P series	22
Sugar alcohols	Ligand exchange + HILIC	SC1211 (Ca <sup>2+</sup> )	26
Oligosaccharides and sugar alcohols	Ligand exchange + SEC	KS-801 (Na <sup>+</sup> ) + KS-802 (Na <sup>+</sup> )	26
Amino sugars	HILIC	VG series	18
		NH2P series	22
	Ion exchange	SC1011 (Ca <sup>2+</sup> )	26
Acidic sugars	Ion exclusion	SH1011 (H <sup>+</sup> )	30
		KC-811	30
	Ion exchange	VT-50 2D	18
		NH2P series	22
Saccharides and organic acids	Ion exclusion + SEC	SH1011 (H <sup>+</sup> ), SH1821 (H <sup>+</sup> )	30
Oligosaccharides	SEC	KS-801 (Na <sup>+</sup> )	26
		SB-802 HQ	40
		GS-220 HQ	44
	HILIC	KS-802 (Na <sup>+</sup> )	26
		SB-802.5 HQ, LB-802.5	40, 41
		GS-320 HQ	44
		VN-50 series	19
		NH2P series	22
Polysaccharides	SEC	KS-803 (Na <sup>+</sup> )	26
		SB-803 HQ, LB-803	40, 41
		KS-804 (Na <sup>+</sup> )	26
		SB-804 HQ, LB-804	40, 41
		SB-805 HQ, LB-805	40, 41
		SB-806 HQ, LB-806	40, 41
		SB-806M HQ, LB-806M	40, 41
SB-807 HQ	40		

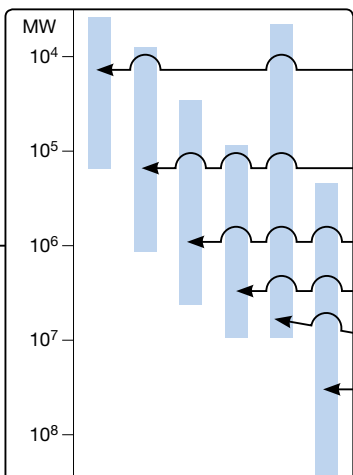
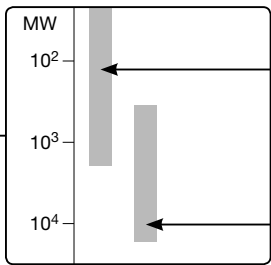



# Column Selection (Drugs, Metabolites and Chiral Compounds)

	Separation Mode	Column	Page
Drugs Metabolites	Reversed phase	ODP2 HP series	12
		ODP-50 series, C4P-50 4D	14
		DS-413, DS-613	16
		DE series	16
		C18M series, C18U series	24
	HILIC	VC-50 2D	18
		VT-50 2D	18
		NH2P series	22
	Ion exchange	NI-424	32
		I-524A	32
		YK-421	33
		ES-502C 7C	62
		Multimode	GS-320 HQ
Chiral compounds	Chiral separation	CDBS-453	64

# Column Selection (Vitamins, Hormones / Neurotransmitters and Lipids)

	Separation Mode	Column	Page
Water-soluble vitamins	Reversed phase	ODP-50 series	14
		DE series	16
		DM-614	16
		C18M series, C18U series	24
	HILIC	VG series	18
		VT-50 2D	18
		NH2P series	22
Multimode	NN-814	16	
Fat-soluble vitamins	Reversed phase	ODP-50 series	14
		C18M series, C18U series	24
	SEC	KF-801, KF-401HQ	48, 52
Hormones / Neurotransmitters	Reversed phase	ODP-50 series	14
		DE series	16
		C18M series, C18U series	24
		SB-802.5 HQ, LB-802.5	40, 41
	HILIC	VC-50 2D	18
		VT-50 2D	18
		NH2P series	22
	Ion exchange	ES-502N 7C	62
		ES-502C 7C	62
	Lipids	Reversed phase	ODP-50 series
DS-413, DS-613			16
DE series			16
SEC		GF-310 HQ	46
		KF-801, KF-802, KF-802.5	48
		KF-402HQ	52

# Column Selection (Anions and Cations)

Separation Mode		Column	Page	
Anions	IC	Inorganic anions analysis (Suppressor method: Sodium carbonate eluent)	SI-90 4E	32
			SI-35 2B	33
		Inorganic anions and organic acids analysis (Suppressor method: Sodium carbonate eluent)	SI-50 4E	32
		Inorganic anions and oxyhalides analysis (Suppressor method: Sodium carbonate eluent)	SI-52 4E	32
			SI-35 4D	32
		Inorganic anions analysis (Suppressor method: Potassium hydroxide eluent)	SI-36 4D	33
	SI-37 4D		33	
	Inorganic anions analysis (Non-suppressor method)	NI-424	32	
		I-524A	32	
	Ion exclusion	Cyanide ions and cyanogen chloride analysis (Post column method)	KC-811 6E	30
Cations	IC	Simultaneous analysis of monovalent and divalent cations (Non-suppressor / Suppressor method) Analysis of alkylamines and/or transition metals	YS-50	33
			YK-421	33

# Column Selection (Polymers)

	Application	Eluent	Column	Page
Aqueous SEC (GFC)	Biological macromolecules (Proteins, Peptides, Nucleic acids, etc.)	Buffer etc.	KW-800 series	36
			KW400 series	36
			LW-803	37
			LW-403 4D	37
	Biological macromolecules (High MW range)	Buffer etc.	SB-800 HQ series	40
			LB-800 series	41
	Water-soluble polymers (Polyacrylamide, etc.)	Water, buffer and aqueous salt solution, etc.	SB-800 HQ series	40
			LB-800 series	41
Organic SEC (GPC)	General polymers	THF	KF-800 series	48
			KF-400HQ series	52
			HK-400 series	54
		Chloroform	LF series	56
			KF-800 series	48
			HK-400 series	54
	Polar polymers (Polyvinylpyrrolidone etc.)	DMF	LF series	56
			SB-800 HQ series	40
			LB-800 series	41
			KD-800 series	50
			HK-400 series	54
			LF series	56
	Engineering plastics (Polyamides etc.)	HFIP	KD-800 series	50
			HK-400 series	54
			LF series	56
Aqueous-Organic SEC			GF-HQ series	46

## Guideline for SEC column selection by solvent usability

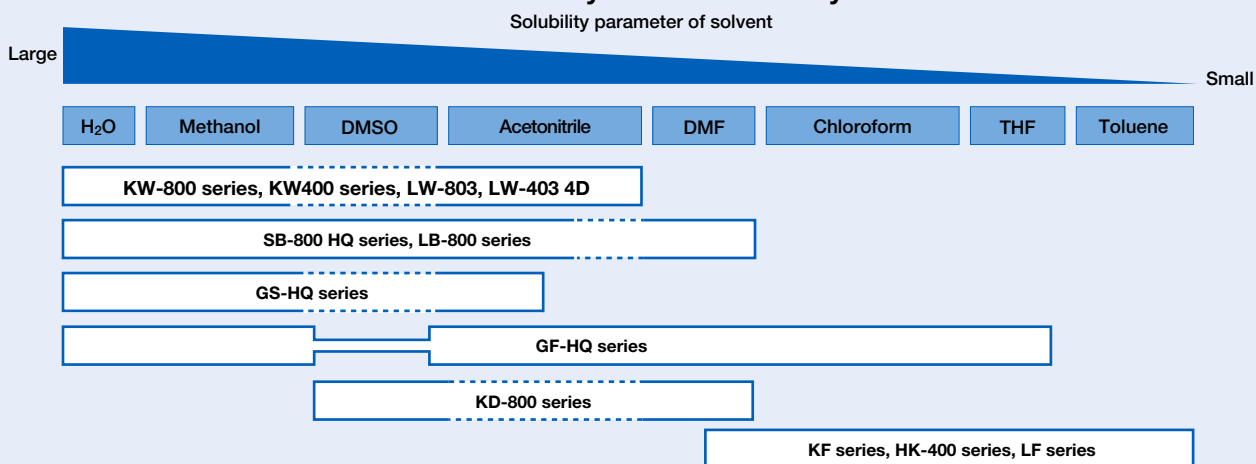

See page 60 for the solvent replaceability of organic solvent SEC (GPC) packed columns.

# Precautions for Polar Polymer Analysis

Unexpected interactions in the column can affect the size exclusion chromatography analysis of polar polymers. These interactions may change elution patterns and results in an invalid molecular weight calculation. It is important to reduce these interfering interactions in order to obtain the accurate molecular weight distribution.

## Interfering interactions likely to be observed

### Interactions between the analyte and the packing materials

- ◆ Hydrophobic interaction
  - The analyte is adsorbed on the packing material.
  - This delays the analyte elution and results in under estimating the analyte's molecular weight. See (B) and (D).
- ◆ Ionic interaction
  - (1) Ion Exclusion
    - The analyte is repelled from the packing material.
    - This accelerates the analyte elution and results in over estimating the analyte's molecular weight. See (A) and (C).
  - (2) Ion Exchange
    - The analyte is adsorbed onto the packing material.
    - This delays the analyte elution and results in under estimating the analyte's molecular weight. See (B) and (D).

### Interaction within and between the analyte

- ◆ Ionic repulsion effects observed within the multivalent macromolecules causes structure expansion
  - This accelerates the analyte elution and results in over estimating the analyte's molecular weight. See (A).
- ◆ Association between the molecules
  - This accelerates the analyte elution and results in over estimating the analyte's molecular weight. See (A).

### Interactions between the analyte and the solvent

- ◆ The multivalent ion in the solvent works as a bridge to bind ionic molecules (analyte).

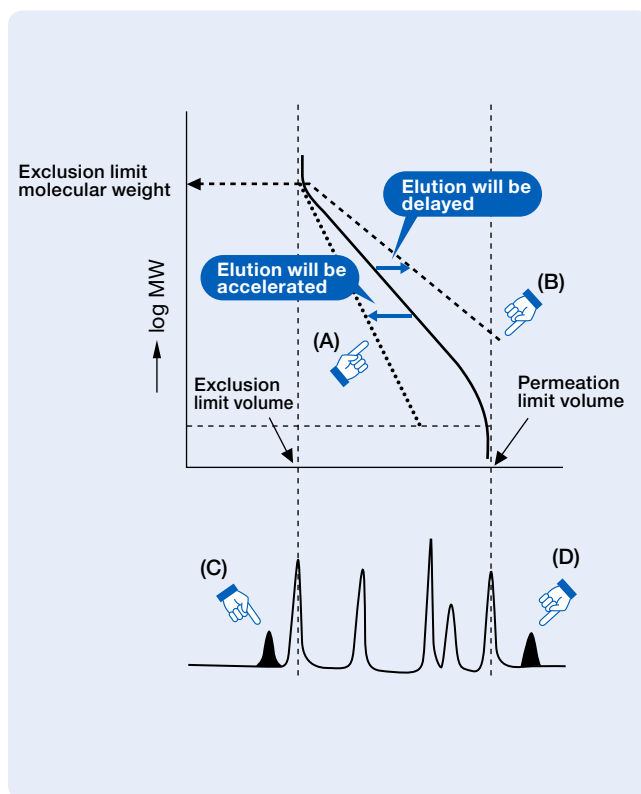

## Methods to reduce interactions

### Aqueous SEC (GFC)

#### Ionic interaction

- ◆ Add salt into the eluent

#### Hydrophobic interaction

- ◆ Increase the analyte dissociation
  - Cationic polymer → Lower the eluent pH
  - Anionic polymer → Higher the eluent pH
- ◆ Lower the eluent polarity
  - e.g. Add acetonitrile or methanol

### Organic SEC (GPC)

#### Ionic interaction

- ◆ Add salt into the eluent
  - e.g. Add LiBr to DMF
  - Add  $\text{CF}_3\text{COONa}$  to HFIP

#### Hydrophobic interaction

- ◆ Lower the eluent polarity
  - e.g. Change the eluent from DMF to THF

#### Hydrophilic interaction

- ◆ Increase the eluent polarity
  - e.g. Change the eluent from THF to DMF



# Polymer-based Reversed Phase Chromatography Columns (ODP2 HP)

## Features

### ODP2 HP

- Provides a large theoretical plate number nearly twice as much as generally available polymer-based reversed phase columns do
- Offers enhanced retention of high polar substances compared to ODS columns
- Suitable for the analysis of small molecules such as pharmaceuticals in the presence of protein matrix
- Ideal for LC/MS analysis of high polar compounds
- Fulfills USP-NF L39 requirements

### Standard columns

Product Code	Product Name	Plate Number (TP/column)	Functional Group	Particle Size (µm)	Pore Size (Å)	Column Size (mm) I.D. x Length	Shipping Solvent
F7622001	<b>ODP2 HP-4B</b>	≥ 3,500	—	5	40	<b>4.6 x 50</b>	H <sub>2</sub> O/CH <sub>3</sub> CN = 55/45
F7622002	<b>ODP2 HP-4D</b>	≥ 10,000	—	5	40	<b>4.6 x 150</b>	H <sub>2</sub> O/CH <sub>3</sub> CN = 55/45
F7622003	<b>ODP2 HP-4E</b>	≥ 17,000	—	5	40	<b>4.6 x 250</b>	H <sub>2</sub> O/CH <sub>3</sub> CN = 55/45
F6714010	<b>ODP2 HPG-4A</b>	(guard column)	—	5	—	<b>4.6 x 10</b>	H <sub>2</sub> O/CH <sub>3</sub> CN = 55/45

Base Material: Polyhydroxymethacrylate

### Semi-micro columns

Product Code	Product Name	Plate Number (TP/column)	Functional Group	Particle Size (µm)	Pore Size (Å)	Column Size (mm) I.D. x Length	Shipping Solvent
F7622004	<b>ODP2 HP-2B</b>	≥ 3,000	—	5	40	<b>2.0 x 50</b>	H <sub>2</sub> O/CH <sub>3</sub> CN = 55/45
F7622005	<b>ODP2 HP-2D</b>	≥ 7,000	—	5	40	<b>2.0 x 150</b>	H <sub>2</sub> O/CH <sub>3</sub> CN = 55/45
F6714011	<b>ODP2 HPG-2A</b>	(guard column)	—	5	—	<b>2.0 x 10</b>	H <sub>2</sub> O/CH <sub>3</sub> CN = 55/45

Base Material: Polyhydroxymethacrylate

### Preparative columns [Preparative columns are made to order]

Product Code	Product Name	Plate Number (TP/column)	Particle Size (µm)	Column Size (mm) I.D. x Length	Shipping Solvent
F6822001	<b>ODP2 HP-10E</b>	≥ 9,500	6	<b>10.0 x 250</b>	H <sub>2</sub> O/CH <sub>3</sub> CN = 55/45
F6714015	<b>ODP2 HPG-7B</b>	(guard column)	6	<b>7.5 x 50</b>	H <sub>2</sub> O/CH <sub>3</sub> CN = 55/45

Base Material: Polyhydroxymethacrylate

## Comparison between ODP2 HP-4D and an ODS column for their alkaline tolerances

### Chromatograms obtained before and after passing alkaline eluent

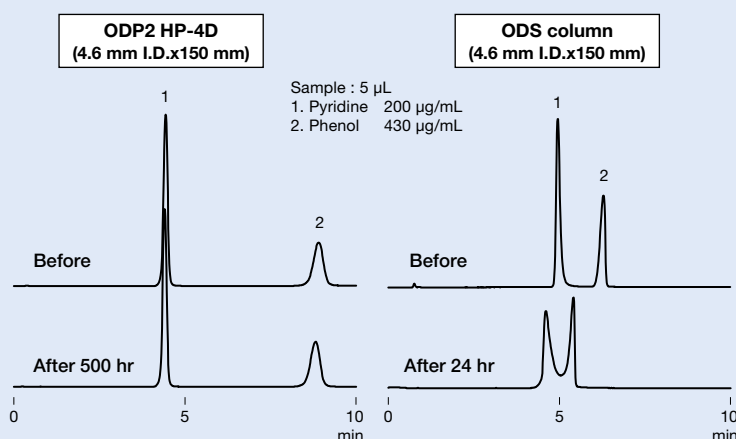

#### Analysis condition

**Column** : Shodex ODP2 HP-4D  
**ODS column from other manufacturer**  
**Eluent** : H<sub>2</sub>O/CH<sub>3</sub>OH = 70/30  
**Flow rate** : 1.0 mL/min  
**Detector** : UV (254 nm)  
**Column temp.** : 40 °C

### Correlation between alkaline eluent passing time and relative theoretical plate number

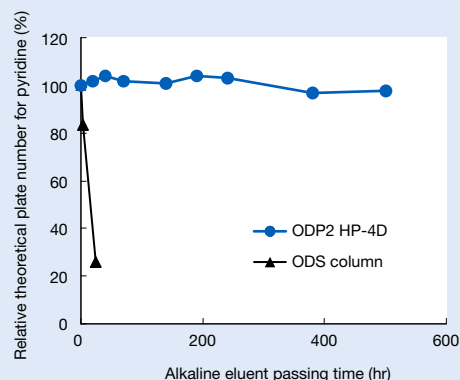

#### Eluent passing conditions for an alkaline tolerance test

**Column** : Shodex ODP2 HP-4D  
**ODS column from other manufacturer**  
**Eluent** : 10 mM Sodium phosphate buffer (pH12) /CH<sub>3</sub>CN = 45/55  
**Flow rate** : 0.6 mL/min  
**Column temp.** : 30 °C

### Comparison between ODP2 HP and ODP-50

Sample : 5  $\mu$ L

1. Phenol 300 mg/L
2. Methyl benzoate 350 mg/L
3. Toluene 1000 mg/L
4. Naphthalene 150 mg/L

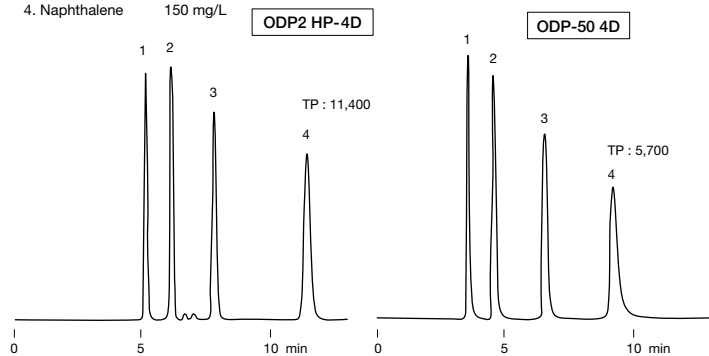

**Column** : Shodex ODP2 HP-4D  
**Eluent** : H<sub>2</sub>O/CH<sub>3</sub>CN = 55/45  
**Flow rate** : 0.6 mL/min  
**Detector** : UV (254 nm)  
**Column temp.** : 40 °C

**Column** : Shodex Asahipak ODP-50 4D  
**Eluent** : H<sub>2</sub>O/CH<sub>3</sub>CN = 35/65  
**Flow rate** : 0.6 mL/min  
**Detector** : UV (254 nm)  
**Column temp.** : 40 °C

### Imidazoles

Sample : 0.1 % each, 10  $\mu$ L

1. Imidazole
2. 2-Methylimidazole
3. 4-Methylimidazole

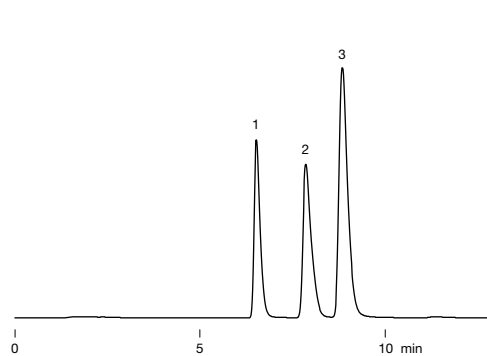

**Column** : Shodex ODP2 HP-4E  
**Eluent** : 10 mM Na<sub>2</sub>HPO<sub>4</sub> aq./CH<sub>3</sub>CN = 90/10  
**Flow rate** : 0.8 mL/min  
**Detector** : UV (220 nm)  
**Column temp.** : 40 °C

### Influence of repeated protein injection on column pressure

ODP2 HP columns are packed with gels with increased surface polarity and smaller pore size which prevent the adsorption of proteins. BSA was injected multiple times to both ODS and ODP2 HP columns. A significant column pressure increase was observed for the ODS column, while no considerable change was observed for the ODP2 HP column even after 140 injections.

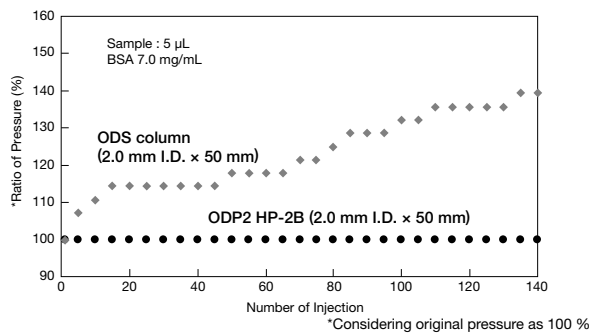

**Column** : Shodex ODP2 HP-2B  
**ODS column from other manufacturer**  
**Eluent** : 1 mM CH<sub>3</sub>COONH<sub>4</sub> aq./CH<sub>3</sub>CN = 90/10  
**Flow rate** : 0.2 mL/min  
**Detector** : UV (220 nm)  
**Column temp.** : 30 °C

### Anticonvulsant in serum

Sample : 20  $\mu$ L

1. 2-Acetaminophen (I.S.) 10  $\mu$ g/mL
2. Zonisamide 13.0  $\mu$ g/mL
3. Phenobarbital 19.0  $\mu$ g/mL
4. Carbamazepine 4.5  $\mu$ g/mL
5. Phenytoin 9.0  $\mu$ g/mL

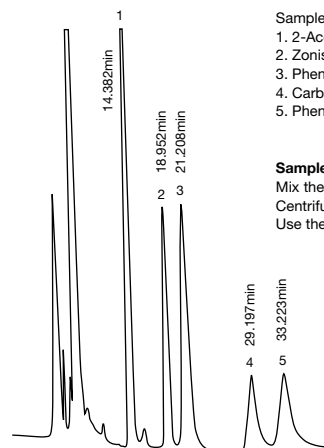

**Sample pretreatment:**  
 Mix the same volumes of serum and acetonitrile. Centrifuge the mixture at 6000 x g for 5 minutes. Use the supernatant as sample.

Data provided by Katsuko Hara.MT  
 Yutaka Komiya .Ph.D.,  
 Department of Clinical Sciences  
 and Laboratory Medicine,  
 Kansai Medical University.

**Column** : Shodex ODP2 HP-4E  
**Eluent** : 25 mM Sodium phosphate buffer (pH5.2)/CH<sub>3</sub>CN = 680/320  
**Flow rate** : 0.35 mL/min  
**Detector** : UV (210 nm)  
**Column temp.** : 40 °C

### Comparison of barbital recovery rate using ODP2 HP-2B and ODS in the presence of BSA

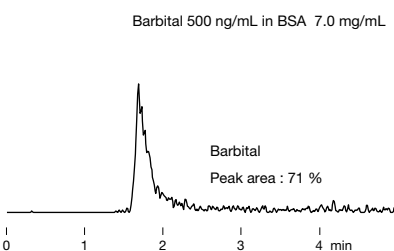
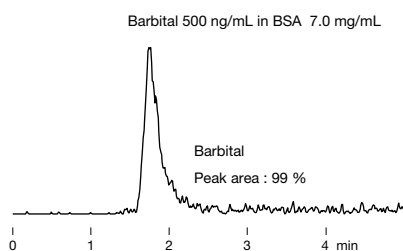
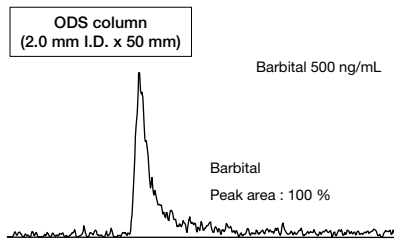
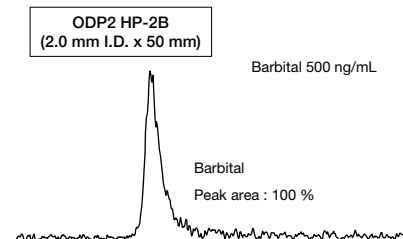

LC/MS analysis of drugs in biological samples is often interfered by ion suppression caused by presence of protein when using general ODS columns. However, ODP2 HP does not retain proteins and elutes them at the void volume. Thus, elution of barbital is not affected when using the ODP2 HP and provides better recovery rate than that of an ODS column.

**Column** : Shodex ODP2 HP-2B  
**ODS column from other manufacturer**  
**Eluent** : 10 mM CH<sub>3</sub>COONH<sub>4</sub> aq./CH<sub>3</sub>CN = 70/30  
**Flow rate** : 0.2 mL/min  
**Detector** : ESI-MS (SIM Negative: m/z 183)  
**Column temp.** : 30 °C  
**Injection vol.** : 10  $\mu$ L

# Polymer-based Reversed Phase Chromatography Columns (Asahipak)

## Features

### ODP-50 C4P-50 4D

- Relatively large pore size is suitable for the analysis of amino acids, peptides, and proteins
- Usable in a wide pH range from pH 2 to 13
- Usable in 100 % water and buffer solution
- Best used for the analysis of basic substances
- ODP-50 fulfills USP-NF L67 requirements

### • Standard columns

Product Code	Product Name	Plate Number (TP/column)	Functional Group	Particle Size (µm)	Pore Size (Å)	Column Size (mm) I.D. x Length	Shipping Solvent
F7620002	<b>Asahipak ODP-50 6D</b>	≥ 9,000	Octadecyl	5	250	<b>6.0 x 150</b>	H <sub>2</sub> O/CH <sub>3</sub> CN = 35/65
F7620001	<b>Asahipak ODP-50 6E</b>	≥ 14,000	Octadecyl	5	250	<b>6.0 x 250</b>	H <sub>2</sub> O/CH <sub>3</sub> CN = 35/65
F6710001	<b>Asahipak ODP-50G 6A</b>	(guard column)	Octadecyl	5	—	<b>6.0 x 10</b>	H <sub>2</sub> O/CH <sub>3</sub> CN = 35/65
F6710023	<b>Asahipak ODP-50 4B</b>	≥ 2,500	Octadecyl	5	250	<b>4.6 x 50</b>	H <sub>2</sub> O/CH <sub>3</sub> CN = 35/65
F7620004	<b>Asahipak ODP-50 4D</b>	≥ 9,000	Octadecyl	5	250	<b>4.6 x 150</b>	H <sub>2</sub> O/CH <sub>3</sub> CN = 35/65
F7620003	<b>Asahipak ODP-50 4E</b>	≥ 14,000	Octadecyl	5	250	<b>4.6 x 250</b>	H <sub>2</sub> O/CH <sub>3</sub> CN = 35/65
F6710022	<b>Asahipak ODP-50G 4A</b>	(guard column)	Octadecyl	5	—	<b>4.6 x 10</b>	H <sub>2</sub> O/CH <sub>3</sub> CN = 35/65
F7620008	<b>Asahipak C4P-50 4D</b>	≥ 6,000	Butyl	5	250	<b>4.6 x 150</b>	H <sub>2</sub> O/CH <sub>3</sub> CN = 35/65
F6710003	<b>Asahipak C4P-50G 4A</b>	(guard column)	Butyl	5	—	<b>4.6 x 10</b>	H <sub>2</sub> O/CH <sub>3</sub> CN = 35/65

Base Material: Polyvinyl alcohol

### • Semi-micro columns

Product Code	Product Name	Plate Number (TP/column)	Functional Group	Particle Size (µm)	Pore Size (Å)	Column Size (mm) I.D. x Length	Shipping Solvent
F7620009	<b>Asahipak ODP-50 2D</b>	≥ 5,000	Octadecyl	5	250	<b>2.0 x 150</b>	H <sub>2</sub> O/CH <sub>3</sub> CN = 35/65
F6713001	<b>Asahipak ODP-50G 2A</b>	(guard column)	Octadecyl	5	—	<b>2.0 x 10</b>	H <sub>2</sub> O/CH <sub>3</sub> CN = 35/65

Base Material: Polyvinyl alcohol

### • Preparative columns [Preparative columns are made to order]

Product Code	Product Name	Plate Number (TP/column)	Functional Group	Particle Size (µm)	Column Size (mm) I.D. x Length	Shipping Solvent
F6820001	<b>Asahipak ODP-50 10E</b>	≥ 10,000	Octadecyl	5	<b>10.0 x 250</b>	H <sub>2</sub> O/CH <sub>3</sub> CN = 35/65
F6820035	<b>Asahipak ODP-90 20F</b>	≥ 9,000	Octadecyl	9	<b>20.0 x 300</b>	H <sub>2</sub> O/CH <sub>3</sub> CN = 35/65
F6710004	<b>Asahipak ODP-130G 7B</b>	(guard column)	Octadecyl	13	<b>7.5 x 50</b>	H <sub>2</sub> O/CH <sub>3</sub> CN = 35/65

Base Material: Polyvinyl alcohol

### Alkaline tolerance of ODP-50

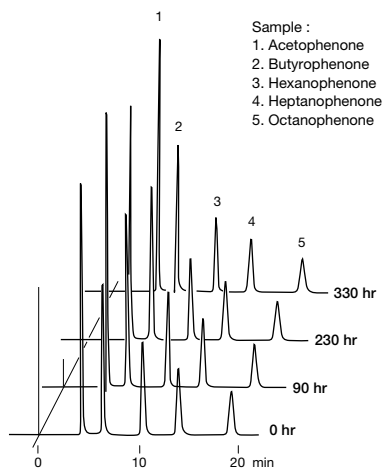

**Column** : Shodex Asahipak ODP-50 4D  
**Eluent** : 10 mM NaOH aq. (pH12.0)/CH<sub>3</sub>CN = 35/65  
**Flow rate** : 0.6 mL/min  
**Detector** : UV (254 nm)  
**Column temp.** : 30 °C

### Local anesthetics

Dissociation of tertiary amino groups in basic drugs can be suppressed by making pH of the eluent higher than pKa of the amino groups. This increases the relative hydrophobicity of the basic drugs, thereby allowing the column to retain the drugs stronger and provide baseline separation of them.

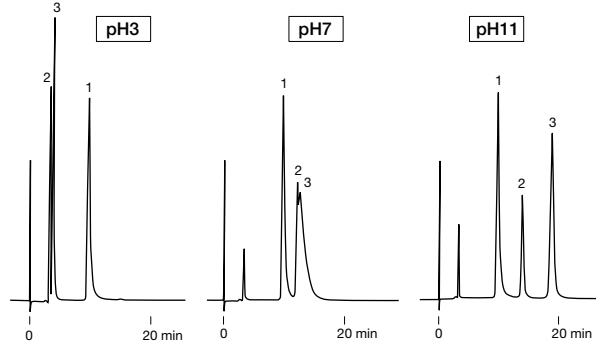

**Column** : Shodex Asahipak ODP-50 4D  
**Eluent** : 25 mM Phosphate buffer/CH<sub>3</sub>CN = 60/40  
**Flow rate** : 0.6 mL/min  
**Detector** : UV (254 nm)  
**Column temp.** : 30 °C

### Unsaturated fatty acids

Sample : 0.002 % each (in Ethanol), 5 µL

1. EPA (Eicosapentaenoic acid)
2. α-Linolenic acid
3. DHA (Docosahexaenoic acid)
4. Arachidonic acid
5. Linoleic acid

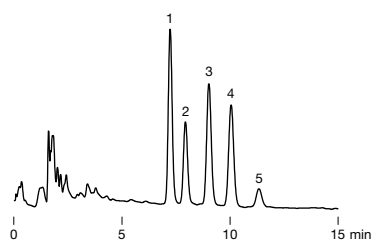

**Column** : Shodex Asahipak ODP-50 4D  
**Eluent** : 0.1 % H<sub>3</sub>PO<sub>4</sub> in (H<sub>2</sub>O/CH<sub>3</sub>CN = 30/70)  
**Flow rate** : 1.0 mL/min  
**Detector** : UV (215 nm)  
**Column temp.** : 40 °C

### Fat-soluble vitamins

Sample : 20 µL

1. Vitamin K<sub>3</sub> 1.5 µg/mL
2. Vitamin A 0.3 µg/mL
3. Vitamin A acetate 1.9 µg/mL
4. Vitamin D<sub>2</sub> 0.3 µg/mL
5. Vitamin D<sub>3</sub> 0.3 µg/mL
6. Vitamin E acetate 2.4 µg/mL
7. Vitamin E 2.5 µg/mL
8. Vitamin K<sub>1</sub> 2.4 µg/mL

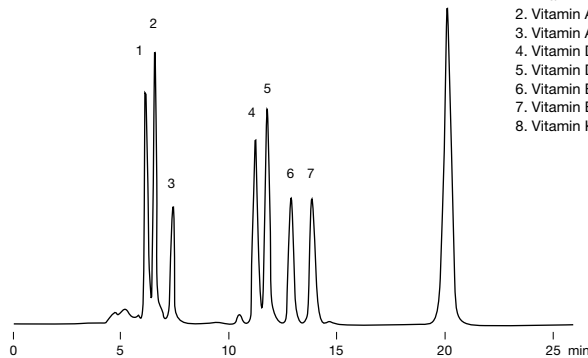

**Column** : Shodex Asahipak ODP-50 4E  
**Eluent** : CH<sub>3</sub>CN/CH<sub>3</sub>OH = 50/50  
**Flow rate** : 0.6 mL/min  
**Detector** : UV (280 nm)  
**Column temp.** : 30 °C

### Analysis of azithromycin according to USP-NF method

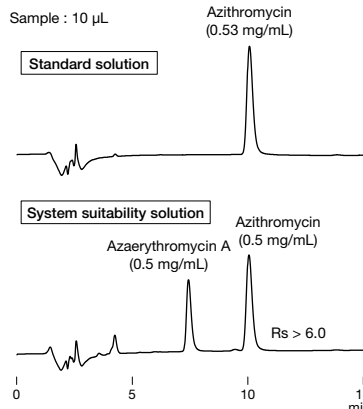

**Column** : Shodex Asahipak ODP-50 4E  
**Eluent** : 6.7 g/L Dibasic potassium phosphate aq. (pH11.0 adjusted with 10 M KOH) /CH<sub>3</sub>CN = 40/60  
**Flow rate** : 1.0 mL/min  
**Detector** : UV (210 nm)  
**Column temp.** : 40 °C

### Gradient analysis of proteins and peptides

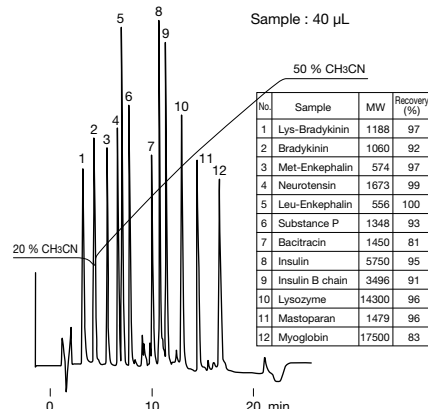

**Column** : Shodex Asahipak ODP-50 6D  
**Eluent** : (A); 0.05 % TFA aq./CH<sub>3</sub>CN = 80/20 (B); 0.05 % TFA aq./CH<sub>3</sub>CN = 50/50 Linear gradient; (A) to (B), 20 min  
**Flow rate** : 1.0 mL/min  
**Detector** : UV (220 nm)  
**Column temp.** : 30 °C

# Polymer-based Reversed Phase Chromatography Columns (RSpak)

## Features

- DS-613**
  - Suitable for reversed phase analysis of highly hydrophilic substances that are not well retained by ODS columns
- DS-413**
  - Fulfill USP-NF L21 requirements

---

- DE-613**
  - General purpose polymer-based column having similar polarity as ODS columns
- DE-413**
  - Wide working pH range (from pH 2 to 12), usable in 100 % water and buffer solutions
- DE-213**
  - Fulfill USP-NF L71 requirements

---

- DM-614**
  - Suitable for the analysis of amino acids and water-soluble vitamins
  - Fulfills USP-NF L39 requirements

---

- NN-814**
  - The packing material modified with sulfo groups supports multimode (reversed phase and cation exchange) analysis
  - Ideal for the analysis of complex samples containing neutral and ionic substances

---

- JJ-50 2D**
  - The packing material is modified with trace amounts of quaternary ammonium groups, and supports multimode (reversed phase and anion exchange) analysis
  - Ideal for analysis of complex samples containing neutral and ionic substances

### DS

#### • Standard columns

Product Code	Product Name	Plate Number (TP/column)	Functional Group	Particle Size (µm)	Pore Size (Å)	Column Size (mm) I.D. x Length	Shipping Solvent
F7001001	<b>RSpak DS-613</b>	≥ 6,500	—	6	200	<b>6.0 x 150</b>	H <sub>2</sub> O/CH <sub>3</sub> CN/THF = 30/40/30
F6700140	<b>RSpak DS-G</b>	(guard column)	—	10	—	<b>4.6 x 10</b>	H <sub>2</sub> O/CH <sub>3</sub> CN/THF = 30/40/30
F7001012	<b>RSpak DS-413</b>	≥ 11,000	—	3.5	200	<b>4.6 x 150</b>	H <sub>2</sub> O/CH <sub>3</sub> CN/THF = 40/30/30

Base Material: Styrene divinylbenzene copolymer

### DE

#### • Standard columns

Product Code	Product Name	Plate Number (TP/column)	Functional Group	Particle Size (µm)	Pore Size (Å)	Column Size (mm) I.D. x Length	Shipping Solvent
F7001004	<b>RSpak DE-613</b>	≥ 7,000	—	6	25	<b>6.0 x 150</b>	H <sub>2</sub> O
F7001005	<b>RSpak DE-413</b>	≥ 11,000	—	4	25	<b>4.6 x 150</b>	H <sub>2</sub> O/CH <sub>3</sub> CN = 50/50
F6700150	<b>RSpak DE-G 4A</b>	(guard column)	—	10	—	<b>4.6 x 10</b>	H <sub>2</sub> O

Base Material: Polymethacrylate

#### • Semi-micro columns

Product Code	Product Name	Plate Number (TP/column)	Functional Group	Particle Size (µm)	Pore Size (Å)	Column Size (mm) I.D. x Length	Shipping Solvent
F7001007	<b>RSpak DE-213</b>	≥ 8,000	—	4	25	<b>2.0 x 150</b>	H <sub>2</sub> O/CH <sub>3</sub> CN = 50/50
F6700151	<b>RSpak DE-G 2A</b>	(guard column)	—	4	—	<b>2.0 x 10</b>	H <sub>2</sub> O/CH <sub>3</sub> CN = 50/50

Base Material: Polymethacrylate

### DM

#### • Standard columns

Product Code	Product Name	Plate Number (TP/column)	Functional Group	Particle Size (µm)	Pore Size (Å)	Column Size (mm) I.D. x Length	Shipping Solvent
F7001002	<b>RSpak DM-614</b>	≥ 4,500	—	10	200	<b>6.0 x 150</b>	5 mM H <sub>3</sub> PO <sub>4</sub> aq.
F6700160	<b>RSpak DM-G 4A</b>	(guard column)	—	12	—	<b>4.6 x 10</b>	5 mM H <sub>3</sub> PO <sub>4</sub> aq.

Base Material: Polyhydroxymethacrylate

### NN

#### • Standard columns

Product Code	Product Name	Plate Number (TP/column)	Functional Group	Particle Size (µm)	Pore Size (Å)	Column Size (mm) I.D. x Length	Shipping Solvent
F7008140	<b>RSpak NN-814</b>	≥ 9,000	Sulfo	10	200	<b>8.0 x 250</b>	0.1 M Sodium phosphate buffer (pH3.0)
F6700510	<b>RSpak NN-G</b>	(guard column)	Sulfo	10	—	<b>6.0 x 50</b>	0.1 M Sodium phosphate buffer (pH3.0)

Base Material: Polyhydroxymethacrylate

### JJ

#### • Semi-micro column

Product Code	Product Name	Plate Number (TP/column)	Functional Group	Particle Size (µm)	Pore Size (Å)	Column Size (mm) I.D. x Length	Shipping Solvent
F7008220	<b>RSpak JJ-50 2D</b>	≥ 3,500	Quaternary ammonium	5	100	<b>2.0 x 150</b>	H <sub>2</sub> O/CH <sub>3</sub> CN = 40/60

Base Material: Polyvinyl alcohol



### Fatty acid methyl esters

Sample : 0.2 % each, 20  $\mu$ L  
 1. Methyl linoleate  
 2. Methyl palmitate  
 3. Methyl oleate  
 4. Methyl stearate

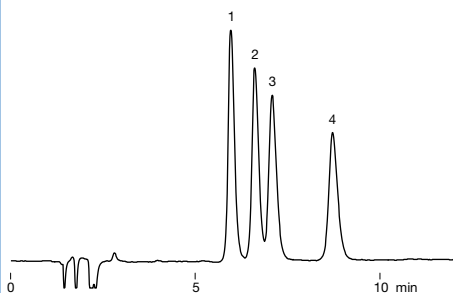

Column : Shodex RSpak DS-413  
 Eluent : H<sub>2</sub>O/CH<sub>3</sub>CN/THF = 25/45/30  
 Flow rate : 1.0 mL/min  
 Detector : RI  
 Column temp. : 40 °C

### Alkylbenzenes

Sample : 5  $\mu$ L  
 1. m-Cresol 0.1 %  
 2. 2,4-Xylenol 0.1 %  
 3. Benzene 0.5 %  
 4. Toluene 0.5 %  
 5. Ethylbenzene 0.5 %  
 6. n-Propylbenzene 0.5 %

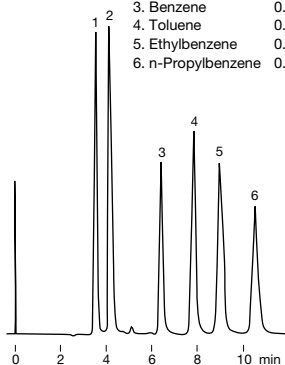

Column : Shodex RSpak DS-613  
 Eluent : H<sub>2</sub>O/CH<sub>3</sub>CN/THF = 30/40/30  
 Flow rate : 1.0 mL/min  
 Detector : UV (254 nm)  
 Column temp. : 40 °C

### Food additives (Preservatives)

Sample : 10  $\mu$ L  
 1. Saccharin sodium 0.005 %  
 2. p-Hydroxybenzoic acid 0.005 %  
 3. Sorbic acid 0.02 %  
 4. Benzoic acid 0.02 %  
 5. Methyl paraben 0.01 %  
 6. Dehydroacetic acid 0.01 %  
 7. Ethyl paraben 0.02 %  
 8. Propyl paraben 0.02 %

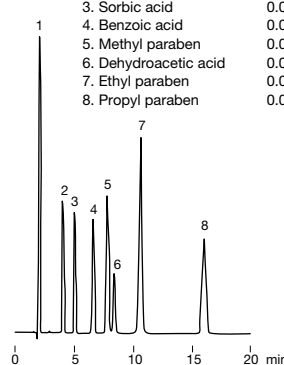

Column : Shodex RSpak DE-413  
 Eluent : 50 mM KH<sub>2</sub>PO<sub>4</sub> + 0.1 % H<sub>3</sub>PO<sub>4</sub> aq./CH<sub>3</sub>CN = 65/35  
 Flow rate : 1.0 mL/min  
 Detector : UV (210 nm)  
 Column temp. : 40 °C

### Vitamins

Sample : 5 mg/L each (in 2.5 mM H<sub>3</sub>PO<sub>4</sub> aq.), 4  $\mu$ L  
 1. Vitamin C  
 2. Orotic acid  
 3. Vitamin B<sub>6</sub>  
 4. Vitamin B<sub>1</sub>  
 5. Nicotinamide  
 6. Caffeine

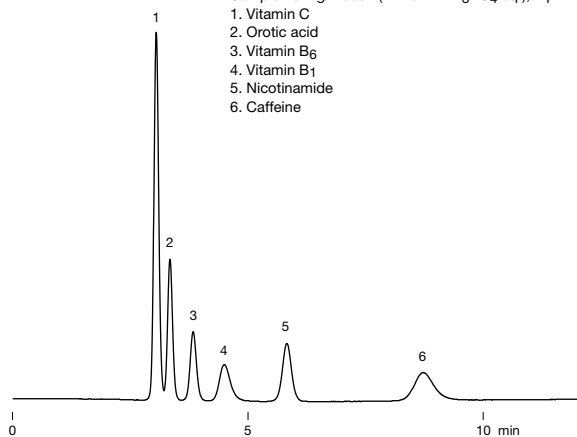

Column : Shodex RSpak DM-614  
 Eluent : 0.055 M Na<sub>2</sub>HPO<sub>4</sub> + 0.045 M KH<sub>2</sub>PO<sub>4</sub> aq.  
 Flow rate : 1.0 mL/min  
 Detector : UV (254 nm)  
 Column temp. : 30 °C

### LC/MS analysis of organic acids

Sample : 50 ng/mL each, 10  $\mu$ L

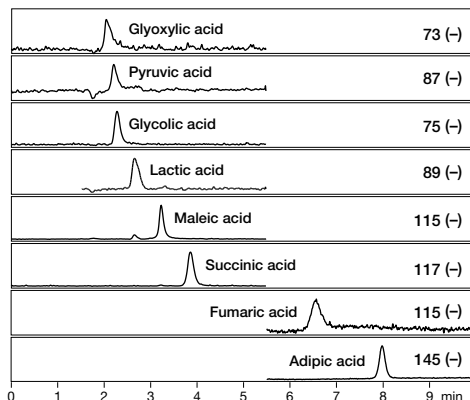

Column : Shodex RSpak DE-213  
 Eluent : (A); 0.1 % (v/v) Formic acid aq./ (B); CH<sub>3</sub>CN  
 Linear gradient; 5 B % (0 to 2 min),  
 5 B % to 15 B % (2 to 2.5 min), 15 B % (2.5 to 10 min)  
 Flow rate : 0.2 mL/min  
 Detector : ESI-MS (SIM)  
 Column temp. : 30 °C

### Amino acids

Sample : 0.1 % each, 20  $\mu$ L  
 1. Aspartic acid  
 2. Glycine  
 3. Alanine  
 4. Valine  
 5. Methionine  
 6. Isoleucine

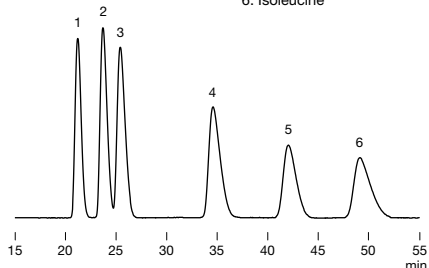

Column : Shodex RSpak NN-814  
 Eluent : 40 mM H<sub>3</sub>PO<sub>4</sub> aq.  
 Flow rate : 1.0 mL/min  
 Detector : RI  
 Column temp. : 40 °C

### High sensitive analysis of chlorate and bromate by LC/MS/MS

Sample : 5  $\mu$ L  
 Standard solution  
 1. ClO<sub>3</sub><sup>-</sup> 0.01 mg/L  
 2. NO<sub>3</sub><sup>-</sup> 0.1 mg/L  
 3. BrO<sub>3</sub><sup>-</sup> 0.01 mg/L  
 4. Br<sup>-</sup> 0.1 mg/L  
 5. Cl<sup>-</sup> 0.1 mg/L  
 6. SO<sub>4</sub><sup>2-</sup> 0.1 mg/L

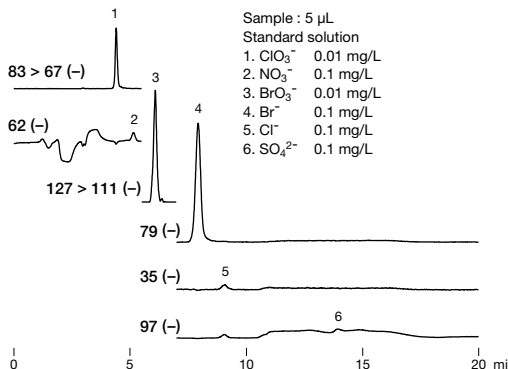

Column : Shodex RSpak JJ-50 2D  
 Eluent : (A); 200 mM HCOONH<sub>4</sub> aq./ (B); CH<sub>3</sub>CN  
 Linear gradient (High pressure);  
 85 B % (0 to 8 min), 85 B % to 50 B % (8 to 9 min), 50 B % (9 to 14 min),  
 50 B % to 85 B % (14 to 15 min), 85 B % (15 to 20 min)  
 Flow rate : 0.3 mL/min  
 Detector : ESI-MS/MS (MRM) for ClO<sub>3</sub><sup>-</sup>, BrO<sub>3</sub><sup>-</sup>  
 ESI-MS (SIM) for NO<sub>3</sub><sup>-</sup>, Br<sup>-</sup>, Cl<sup>-</sup>, SO<sub>4</sub><sup>2-</sup>  
 Column temp. : 50 °C

# Polymer-based Hydrophilic Interaction Chromatography (HILIC) Columns (HILICpak)

## Features

### VG-25 **New** VG-50

- Suitable for saccharide analysis using HILIC mode
- High recovery rate of reducing saccharides
- Polymer-based packing material provides excellent chemical stability and minimum deterioration over an extended time period
- Easily regenerated by washing in an alkaline solution
- Appropriate for evaporative light scattering detector, corona charged aerosol detector, and LC/MS
- With smaller packing material, VG-25 provides an improved separation ability

### VT-50 2D

- Suitable for anionic substances (especially phosphate compounds) analysis using HILIC mode
- Use of some eluents add ion exchange mode
- Polymer-based packing material provides excellent chemical stability and minimum deterioration over an extended time period
- Suitable for LC/MS analysis

### VC-50 2D

- Modified carboxyl group is suitable for cationic substance analysis including amines
- The dominant separation mode is RP or IEX rather than HILIC mode

### VN-50

- The modified diol groups on the packing material create the HILIC mode
- Suitable for oligonucleotide and oligosaccharide separation which is not possible by SEC or conventional HILIC columns
- Physical weakness of PEEK housing is supported by adopting double structured, outer SUS, housing for VN-50 1D, which allows its use under high pressure conditions
- Small inner diameter (1.0 mm) of VN-50 1D allows its use at 0.1-mL/min flow rate, which is suitable for LC/MS high sensitivity analyses

## VG

- **Standard columns** (Housing Material: PEEK [VG-25 series], SUS [VG-50 series])

Product Code	Product Name	Plate Number (TP/column)	Functional Group	Particle Size (μm)	Pore Size (Å)	Column Size (mm) I.D. x Length	Shipping Solvent
F7631000	<b>HILICpak VG-25 4D</b> <b>New</b>	≥ 16,500	Amino	2.5	130	<b>4.6 x 150</b>	H <sub>2</sub> O/CH <sub>3</sub> CN = 20/80
F6711800	<b>HILICpak VG-25G 4A</b> <b>New</b>	(guard column)	Amino	2.5	130	<b>4.6 x 10</b>	H <sub>2</sub> O/CH <sub>3</sub> CN = 20/80
F7630200	<b>HILICpak VG-50 4D</b>	≥ 5,500	Amino	5	100	<b>4.6 x 150</b>	H <sub>2</sub> O/CH <sub>3</sub> CN = 20/80
F7630100	<b>HILICpak VG-50 4E</b>	≥ 7,500	Amino	5	100	<b>4.6 x 250</b>	H <sub>2</sub> O/CH <sub>3</sub> CN = 20/80
F6711100	<b>HILICpak VG-50G 4A</b>	(guard column)	Amino	5	100	<b>4.6 x 10</b>	H <sub>2</sub> O/CH <sub>3</sub> CN = 20/80

Base Material: Polyvinyl alcohol

- **Semi-micro columns** (Housing Material: PEEK)

Product Code	Product Name	Plate Number (TP/column)	Functional Group	Particle Size (μm)	Pore Size (Å)	Column Size (mm) I.D. x Length	Shipping Solvent
F7631100	<b>HILICpak VG-25 2B</b> <b>New</b>	≥ 3,500	Amino	2.5	130	<b>2.0 x 50</b>	H <sub>2</sub> O/CH <sub>3</sub> CN = 15/85
F6711900	<b>HILICpak VG-25G 2A</b> <b>New</b>	(guard column)	Amino	2.5	130	<b>2.0 x 10</b>	H <sub>2</sub> O/CH <sub>3</sub> CN = 15/85
F7630300	<b>HILICpak VG-50 2D</b>	≥ 3,500	Amino	5	100	<b>2.0 x 150</b>	H <sub>2</sub> O/CH <sub>3</sub> CN = 15/85
F6711200	<b>HILICpak VG-50G 2A</b>	(guard column)	Amino	5	100	<b>2.0 x 10</b>	H <sub>2</sub> O/CH <sub>3</sub> CN = 15/85

Base Material: Polyvinyl alcohol

## VT-50

- **Semi-micro columns** (Housing Material: PEEK)

Product Code	Product Name	Plate Number (TP/column)	Functional Group	Particle Size (μm)	Pore Size (Å)	Column Size (mm) I.D. x Length	Shipping Solvent
F7630400	<b>HILICpak VT-50 2D</b>	≥ 4,500	Quaternary ammonium	5	100	<b>2.0 x 150</b>	25 mM HCOONH <sub>4</sub> aq./ CH <sub>3</sub> CN = 15/85
F6711300	<b>HILICpak VT-50G 2A</b>	(guard column)	Quaternary ammonium	5	100	<b>2.0 x 10</b>	25 mM HCOONH <sub>4</sub> aq./ CH <sub>3</sub> CN = 15/85

Base Material: Polyvinyl alcohol

## VC-50

- **Semi-micro columns** (Housing Material: PEEK)

Product Code	Product Name	Plate Number (TP/column)	Functional Group	Particle Size (μm)	Pore Size (Å)	Column Size (mm) I.D. x Length	Shipping Solvent
F7630700	<b>HILICpak VC-50 2D</b>	≥ 3,500	Carboxyl	5	100	<b>2.0 x 150</b>	H <sub>2</sub> O
F6711600	<b>HILICpak VC-50G 2A</b>	(guard column)	Carboxyl	5	100	<b>2.0 x 10</b>	H <sub>2</sub> O

Base Material: Polyvinyl alcohol

**VN-50**
**Standard columns** (Housing Material: PEEK)

Product Code	Product Name	Plate Number (TP/column)	Functional Group	Particle Size (µm)	Pore Size (Å)	Column Size (mm) I.D. x Length	Shipping Solvent
F7630500	<b>HILICpak VN-50 4D</b>	≥ 10,000	Diol	5	100	<b>4.6 x 150</b>	H <sub>2</sub> O/CH <sub>3</sub> CN = 25/75
F6711400	<b>HILICpak VN-50G 4A</b>	(guard column)	Diol	5	100	<b>4.6 x 10</b>	H <sub>2</sub> O/CH <sub>3</sub> CN = 25/75

Base Material: Polyvinyl alcohol

**Semi-micro columns** (Housing Material: PEEK)

Product Code	Product Name	Plate Number (TP/column)	Functional Group	Particle Size (µm)	Pore Size (Å)	Column Size (mm) I.D. x Length	Shipping Solvent
F7630600	<b>HILICpak VN-50 2D</b>	≥ 3,500	Diol	5	100	<b>2.0 x 150</b>	H <sub>2</sub> O/CH <sub>3</sub> CN = 25/75
F6711500	<b>HILICpak VN-50G 2A</b>	(guard column)	Diol	5	100	<b>2.0 x 10</b>	H <sub>2</sub> O/CH <sub>3</sub> CN = 25/75

Base Material: Polyvinyl alcohol

**Semi-micro columns** (Housing material: Outer SUS and inner (wetted part) PEEK double structure) [VN-50 1D is made to order]

Product Code	Product Name	Plate Number (TP/column)	Functional Group	Particle Size (µm)	Pore Size (Å)	Column Size (mm) I.D. x Length	Shipping Solvent
F7630800	<b>HILICpak VN-50 1D</b> <span style="color: blue; font-weight: bold;">New</span>	≥ 2,800	Diol	5	100	<b>1.0 x 150</b>	H <sub>2</sub> O/CH <sub>3</sub> CN = 25/75

Base Material: Polyvinyl alcohol

**Preparative columns** (Housing Material: SUS [VN-50 10E], PEEK [VN-50G 4A]) [VN-50 10E is made to order]

Product Code	Product Name	Plate Number (TP/column)	Functional Group	Particle Size (µm)	Column Size (mm) I.D. x Length	Shipping Solvent
F6830100	<b>HILICpak VN-50 10E</b>	≥ 11,000	Diol	5	<b>10.0 x 250</b>	H <sub>2</sub> O/CH <sub>3</sub> CN = 25/75
F6711400	<b>HILICpak VN-50G 4A</b>	(guard column)	Diol	5	<b>4.6 x 10</b>	H <sub>2</sub> O/CH <sub>3</sub> CN = 25/75

Base Material: Polyvinyl alcohol

**Comparisons of separation ability**

The new VG-25 4D showed significantly higher theoretical plate number over VG-50 4D. It also provided superior separation over other manufacturer's column (3 µm particles).

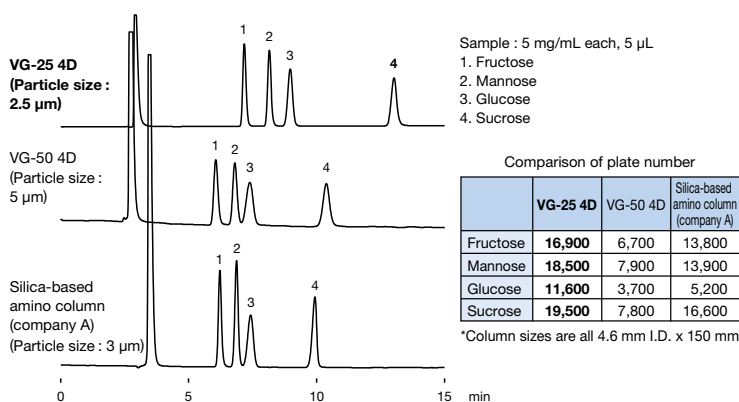

**Column** : Shodex HILICpak VG-25 4D, Shodex HILICpak VG-50 4D  
**Silica-based amino column from other manufacturer**  
 Eluent : H<sub>2</sub>O/CH<sub>3</sub>CN = 20/80  
 Flow rate : 0.6 mL/min  
 Detector : RI  
 Column temp. : 40 °C

**Maltodextrin**

VG-25 4D can analyze oligosaccharides in a range of 1 to 15 saccharides using an isocratic elution instead of gradient elution generally used.

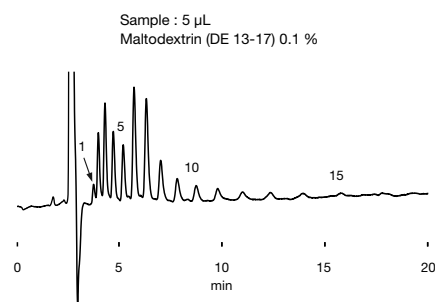

Note : The numbers mentioned on the chromatogram peaks are degree of polymerization (Dp).

**Column** : Shodex HILICpak VG-25 4D  
 Eluent : H<sub>2</sub>O/CH<sub>3</sub>CN = 35/65  
 Flow rate : 0.6 mL/min  
 Detector : RI  
 Column temp. : 60 °C

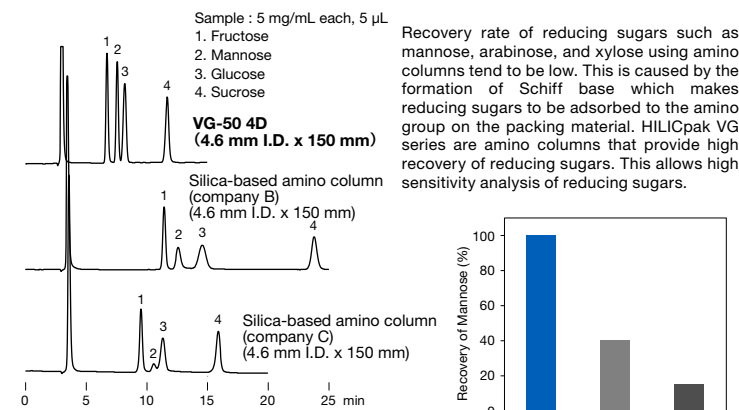
**Recovery of reducing sugar**

**Column** : Shodex HILICpak VG-50 4D  
**Silica based amino columns from other manufacturers**  
 Eluent : H<sub>2</sub>O/CH<sub>3</sub>CN = 20/80  
 Flow rate : 0.6 mL/min (VG-50 4D)  
 1.0 mL/min (Silica based amino column)  
 Detector : RI  
 Column temp. : 40 °C

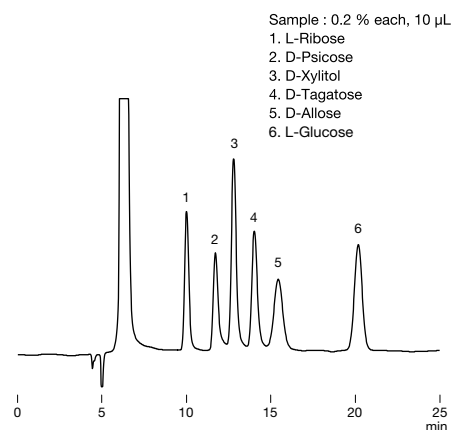
**Rare sugar**

**Column** : Shodex HILICpak VG-50 4E  
 Eluent : H<sub>2</sub>O/CH<sub>3</sub>CN/CH<sub>3</sub>OH = 5/85/10  
 Flow rate : 0.6 mL/min  
 Detector : RI  
 Column temp. : 50 °C

## Simultaneous analysis of saccharides, organic acids and amino acids with LC/MS

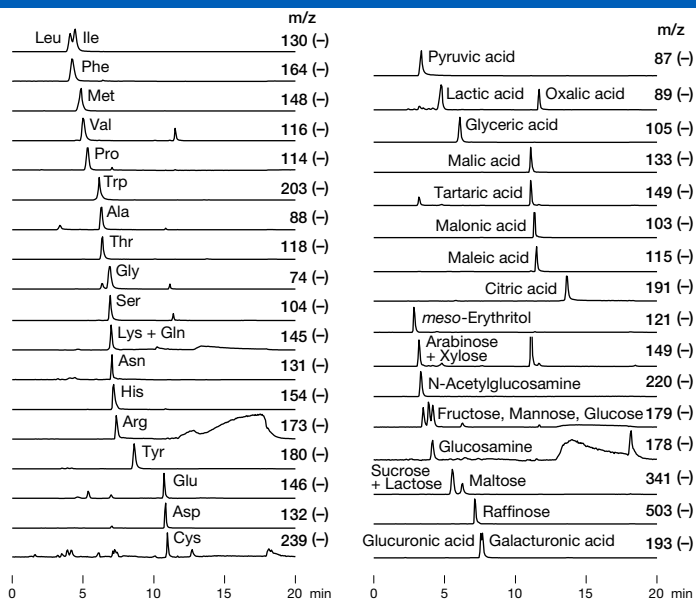

Sample : 1 µg/mL each (in H<sub>2</sub>O/CH<sub>3</sub>CN = 1/4), 5 µL

VG-50 2D allows simultaneous analysis of saccharides, organic acids and amino acids with LC/MS detection under alkaline conditions. High anionic substances elute under alkaline conditions. Furthermore, alkaline conditions promote the deprotonation of hydroxyl groups at the time of ionization. Therefore, alkaline conditions are suitable for high sensitive detection of substances with hydroxyl groups such as saccharides under the negative mode.

**Column** : Shodex HILICpak VG-50 2D  
**Eluent** : (A); 0.5 % NH<sub>3</sub> aq./ (B); CH<sub>3</sub>CN  
 Linear gradient (High pressure);  
 80 B % (0 to 2 min), 80 B % to 10 B % (2 to 12 min),  
 10 B % (12 to 15 min), 80 B % (15 to 20 min)  
**Flow rate** : 0.2 mL/min  
**Detector** : ESI-MS (SIM)  
**Column temp.** : 40 °C

## Lactose, epilactose, and lactulose

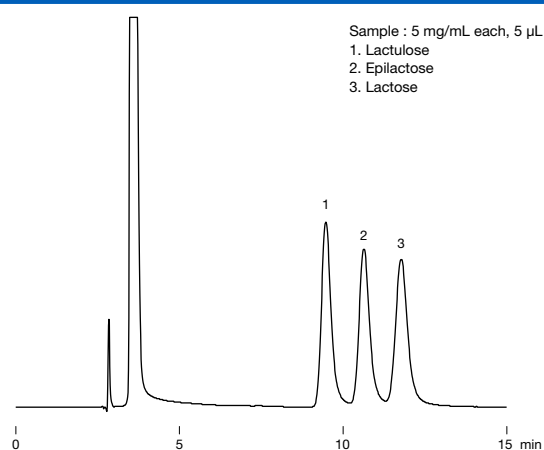

**Column** : Shodex HILICpak VG-50 4E  
**Eluent** : H<sub>2</sub>O/CH<sub>3</sub>CN/CH<sub>3</sub>OH = 5/75/20  
**Flow rate** : 1.0 mL/min  
**Detector** : RI  
**Column temp.** : 40 °C

## LC/MS analysis of pantothenic acid and vitamin C

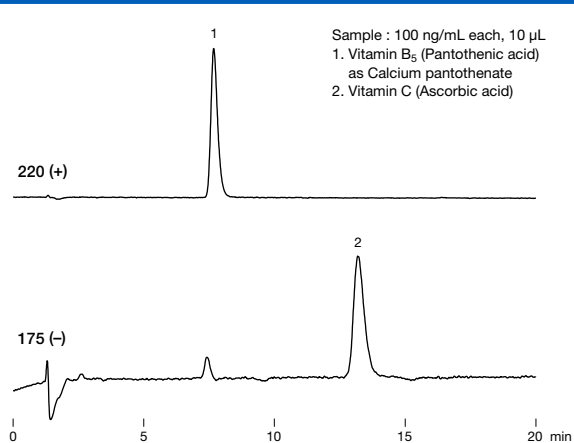

**Column** : Shodex HILICpak VT-50 2D  
**Eluent** : 50 mM HCOONH<sub>4</sub> aq./CH<sub>3</sub>CN = 30/70  
**Flow rate** : 0.2 mL/min  
**Detector** : ESI-MS (SIM)  
**Column temp.** : 30 °C

## LC/MS/MS analysis of organic sulfonic acids

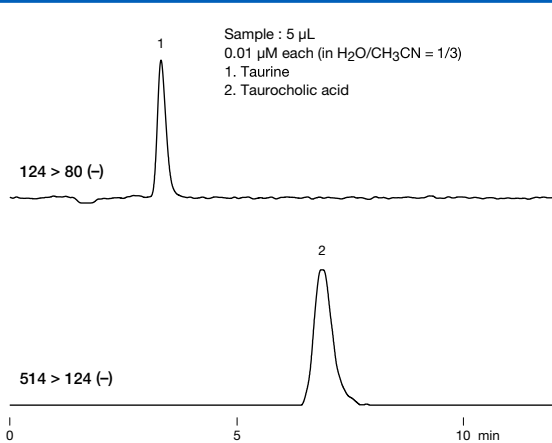

**Column** : Shodex HILICpak VT-50 2D  
**Eluent** : 50 mM HCOONH<sub>4</sub> aq./CH<sub>3</sub>CN = 20/80  
**Flow rate** : 0.3 mL/min  
**Detector** : ESI-MS/MS (MRM)  
**Column temp.** : 30 °C

## LC/MS/MS analysis of glyphosate and glufosinate

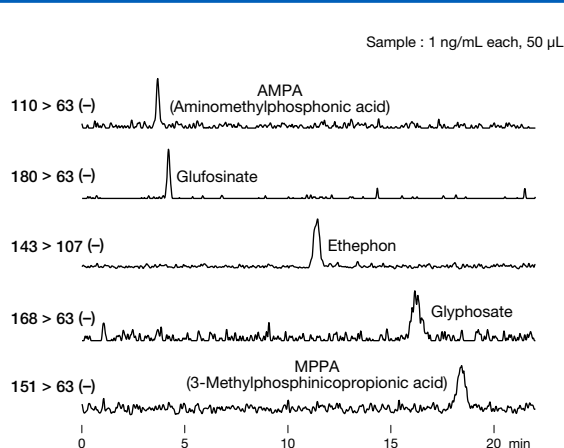

**Column** : Shodex HILICpak VT-50 2D  
**Eluent** : 50 mM NH<sub>4</sub>HCO<sub>3</sub> aq./CH<sub>3</sub>CN = 50/50  
**Flow rate** : 0.3 mL/min  
**Detector** : ESI-MS/MS (MRM)  
**Column temp.** : 40 °C

### LC/MS analysis of aminoglycoside antibiotics

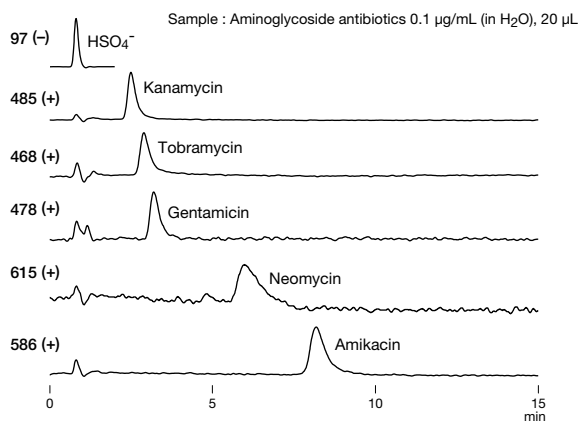

**Column** : Shodex HILICpak VC-50 2D  
 Eluent : (A); 1.5 % NH<sub>3</sub> aq./ (B); CH<sub>3</sub>CN  
 Linear gradient (High pressure);  
 30 B % to 10 B % (0 to 5 min), 10 B % (5 to 15 min)  
 Flow rate : 0.3 mL/min  
 Detector : ESI-MS (SIM)  
 Column temp. : 40 °C

### LC/MS analysis of phosphorylated saccharides

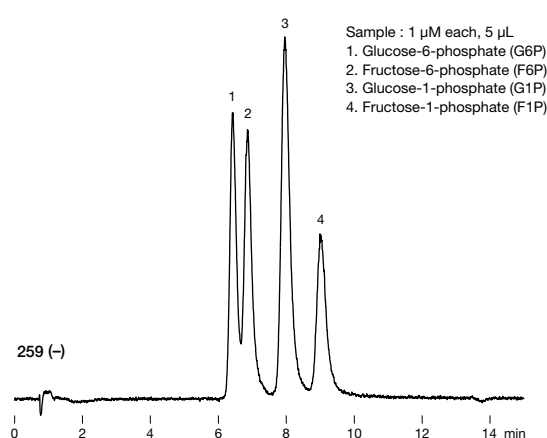

**Column** : Shodex HILICpak VT-50 2D  
 Eluent : 25 mM HCOONH<sub>4</sub> aq./CH<sub>3</sub>CN = 80/20  
 Flow rate : 0.3 mL/min  
 Detector : ESI-MS (SIM)  
 Column temp. : 60 °C

### LC/MS analysis of oligo DNA

Sample : 1 µL  
 Synthesized oligo DNA 20 mer (ATACCGATTAAGCGAAGTTT; crude)  
 2.2 mg/mL (in H<sub>2</sub>O)

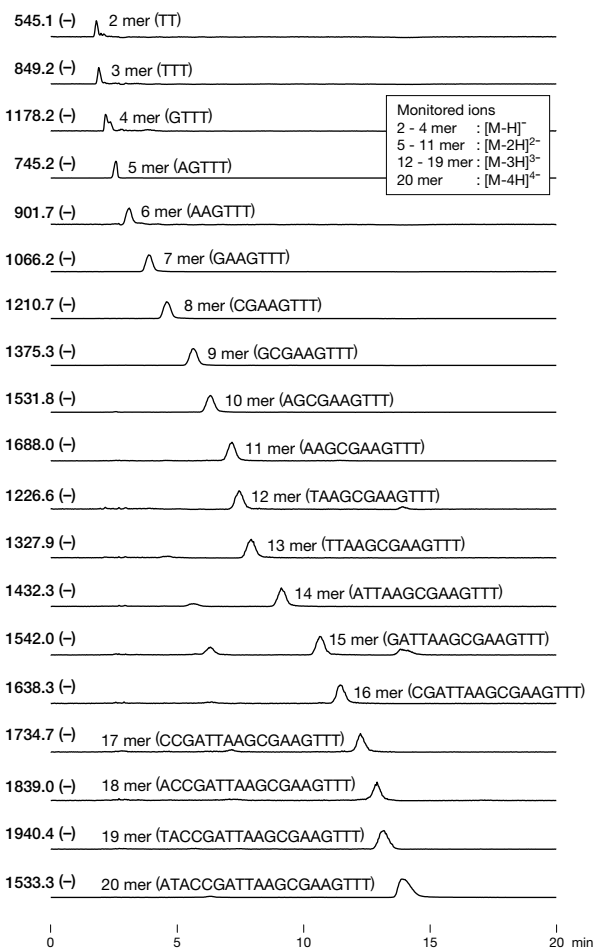

Monitored ions  
 2 - 4 mer : [M-H]<sup>-</sup>  
 5 - 11 mer : [M-2H]<sup>2-</sup>  
 12 - 19 mer : [M-3H]<sup>3-</sup>  
 20 mer : [M-4H]<sup>4-</sup>

**Column** : Shodex HILICpak VN-50 2D  
 Eluent : (A); 50 mM HCOONH<sub>4</sub> aq./ (B); CH<sub>3</sub>CN  
 Linear gradient;  
 60 B % (0 to 10 min), 60 B % to 55 B % (10 to 15 min),  
 60 B % (15 to 20 min)  
 Flow rate : 0.2 mL/min  
 Detector : ESI-MS (SIM)  
 Column temp. : 40 °C

### LC/MS/MS analysis of monoamine neurotransmitters

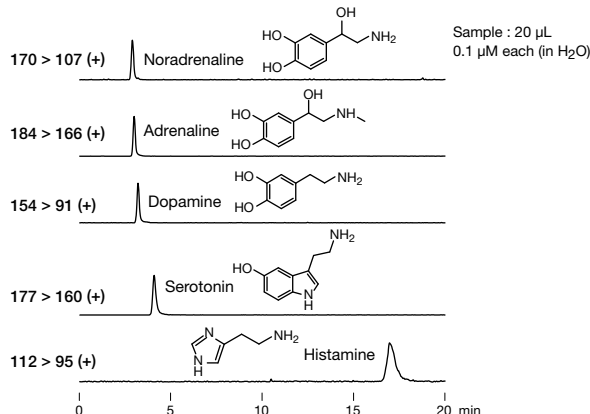

**Column** : Shodex HILICpak VC-50 2D  
 Eluent : (A); 200 mM HCOOH aq./ (B); CH<sub>3</sub>CN  
 Linear gradient (High pressure);  
 60 B % (0 to 5 min), 60 B % to 10 B % (5 to 6 min), 10 B % (6 to 20 min)  
 Flow rate : 0.3 mL/min  
 Detector : ESI-MS/MS (MRM)  
 Column temp. : 40 °C

### High sensitive analysis of oligo DNA by VN-50 1D

Sample : 0.4 µL  
 Synthesized oligo-DNA 19mer (TTCTCATGGTCTTCGGAA ; crude)  
 Synthesized oligo-DNA 20mer (CTTCTCATGGTCTTCGGAA ; crude)  
 0.05 mg/mL each (in H<sub>2</sub>O/CH<sub>3</sub>CN=50/50)

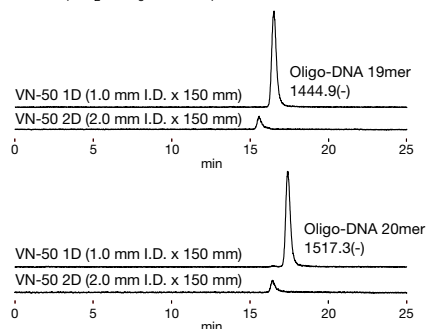

**Column** : Shodex HILICpak VN-50 1D, Shodex HILICpak VN-50 2D  
 Eluent : (A); 50 mM HCOONH<sub>4</sub> aq. / (B); CH<sub>3</sub>CN  
 Linear gradient;  
 65 B % to 50 B % (0 to 20 min), 50 B % to 65 B % (20 to 20.01 min),  
 65 B % (20.01 to 25 min)  
 Flow rate : 0.1 mL/min (VN-50 1D), 0.3 mL/min (VN-50 2D)  
 Detector : ESI-MS (SIM Negative)  
 Column temp. : 40 °C



# Polymer-based Hydrophilic Interaction Chromatography (HILIC) Columns (Asahipak)

## Features

- NH2P-50**
- Suitable for saccharides analysis using HILIC mode
  - Polymer-based packing material provides excellent chemical stability and minimum deterioration over extended time period
  - Easily regenerated by washing in an alkaline solution
  - Appropriate for evaporative light scattering detector, corona charged aerosol detector, and LC/MS
  - Fulfills USP-NF L82 requirements
- NH2P-40**
- Provides higher theoretical plate number than NH2P-50 series

## Standard columns

Product Code	Product Name	Plate Number (TP/column)	Functional Group	Particle Size (µm)	Pore Size (Å)	Column Size (mm) I.D. x Length	Shipping Solvent
F7630005	<b>Asahipak NH2P-50 4B</b>	≥ 1,500	Amino	5	100	<b>4.6 x 50</b>	CH <sub>3</sub> CN
F7630002	<b>Asahipak NH2P-50 4D</b>	≥ 5,500	Amino	5	100	<b>4.6 x 150</b>	CH <sub>3</sub> CN
F7630001	<b>Asahipak NH2P-50 4E</b>	≥ 7,500	Amino	5	100	<b>4.6 x 250</b>	CH <sub>3</sub> CN
F6710016	<b>Asahipak NH2P-50G 4A</b>	(guard column)	Amino	5	—	<b>4.6 x 10</b>	CH <sub>3</sub> CN
F7630007	<b>Asahipak NH2P-40 3E</b>	≥ 8,500	Amino	4	100	<b>3.0 x 250</b>	CH <sub>3</sub> CN
F6710030	<b>Asahipak NH2P-50G 3A</b>	(guard column)	Amino	5	—	<b>3.0 x 10</b>	CH <sub>3</sub> CN

Base Material: Polyvinyl alcohol

## Semi-micro columns

Product Code	Product Name	Plate Number (TP/column)	Functional Group	Particle Size (µm)	Pore Size (Å)	Column Size (mm) I.D. x Length	Shipping Solvent
F7630006	<b>Asahipak NH2P-50 2D</b>	≥ 3,500	Amino	5	100	<b>2.0 x 150</b>	CH <sub>3</sub> CN
F6713000	<b>Asahipak NH2P-50G 2A</b>	(guard column)	Amino	5	—	<b>2.0 x 10</b>	CH <sub>3</sub> CN
F7630010	<b>Asahipak NH2P-40 2E</b>	≥ 7,000	Amino	4	100	<b>2.0 x 250</b>	CH <sub>3</sub> CN

Base Material: Polyvinyl alcohol

## Preparative columns [Preparative columns are made to order]

Product Code	Product Name	Plate Number (TP/column)	Functional Group	Particle Size (µm)	Column Size (mm) I.D. x Length	Shipping Solvent
F6830001	<b>Asahipak NH2P-50 10E</b>	≥ 10,000	Amino	5	<b>10.0 x 250</b>	CH <sub>3</sub> CN
F6710016	<b>Asahipak NH2P-50G 4A</b>	(guard column)	Amino	5	<b>4.6 x 10</b>	CH <sub>3</sub> CN
F6830031	<b>Asahipak NH2P-90 20F</b>	≥ 10,000	Amino	9	<b>20.0 x 300</b>	CH <sub>3</sub> CN
F6710017	<b>Asahipak NH2P-130G 7B</b>	(guard column)	Amino	13	<b>7.5 x 50</b>	CH <sub>3</sub> CN

Base Material: Polyvinyl alcohol

### Comparison of saccharide analysis using corona charged aerosol detector

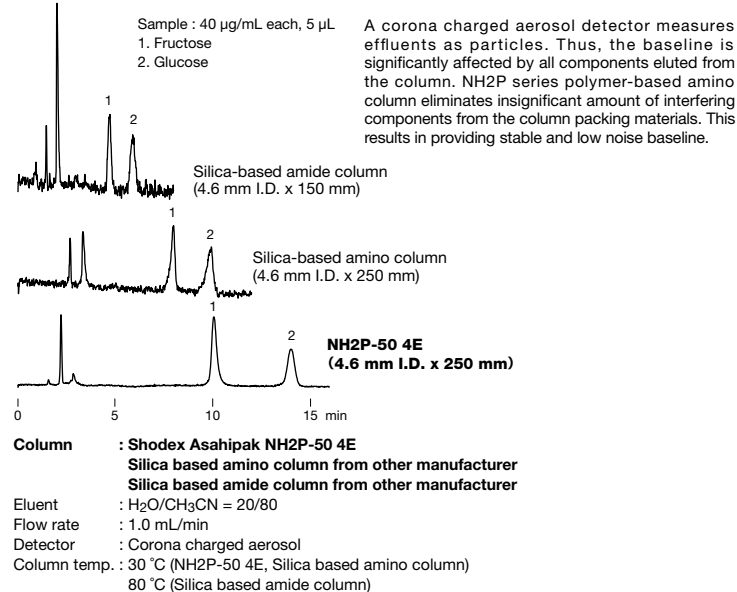

### Fructooligosaccharide syrup

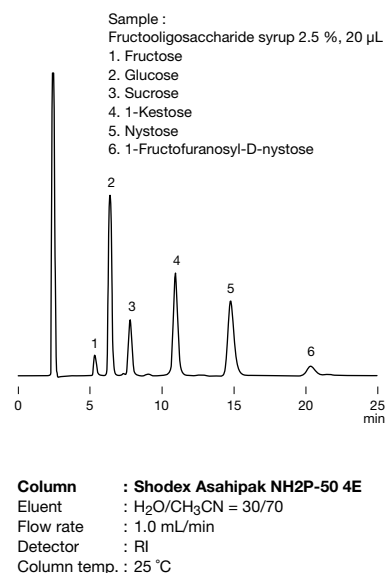

### Cyclodextrins

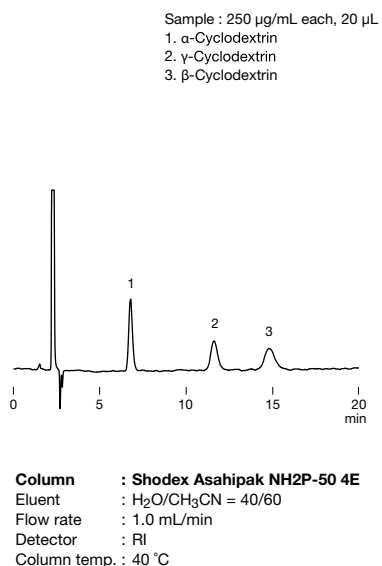

### Stevioside and rebaudioside A

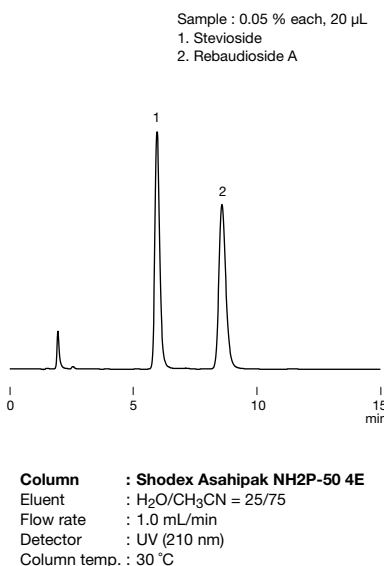

### Ginsenosides in ginseng tea

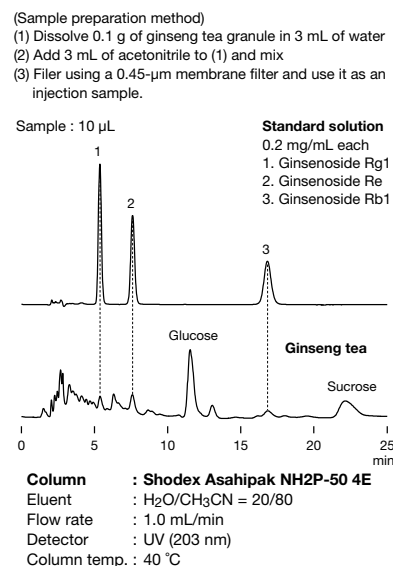

### Imidazole dipeptides

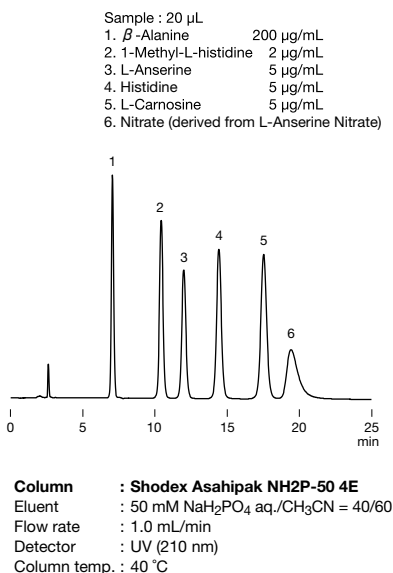

### Simultaneous analysis of water-soluble vitamins

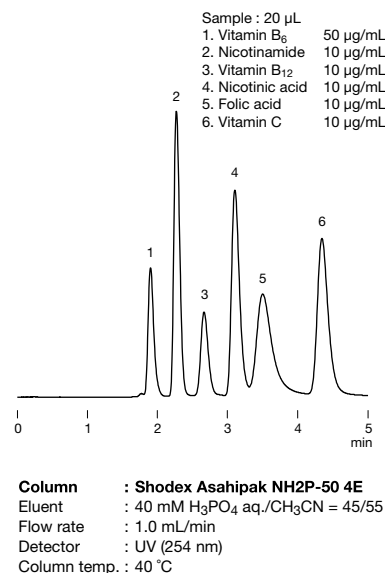

### Ascorbic acid and erythorbic acid

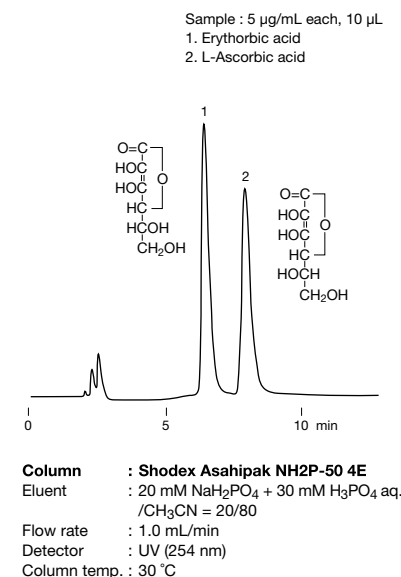

# Silica-based Reversed Phase Chromatography Columns (ODS Columns)

## Features

### C18M

- Monomeric type ODS column, fully end capped high purity silica (99.99 % or higher)
- Fulfills USP-NF L1 requirements

### • Standard columns

Product Code	Product Name	Plate Number (TP/column)	Functional Group	Particle Size (µm)	Carbon Load (%)	Pore Size (Å)	Column Size (mm) I.D. x Length	Shipping Solvent
F6650040	<b>Silica C18M 4D</b>	≥ 10,000	Octadecyl	5	16	100	<b>4.6 x 150</b>	H <sub>2</sub> O/CH <sub>3</sub> OH = 30/70
F6650041	<b>Silica C18M 4E</b>	≥ 16,000	Octadecyl	5	16	100	<b>4.6 x 250</b>	H <sub>2</sub> O/CH <sub>3</sub> OH = 30/70

Base Material: Silica

# Silica-based Reversed Phase Chromatography Columns (ODS Columns for UHPLC)

## Features

### C18U

- ODS columns for UHPLC (Maximum pressure: 100 MPa)
- Achieves high performance analysis with sub-2 µm particles
- Organic/inorganic silica hybrid particles provide excellent resolution and mechanical stability and improved alkali durability (from pH 1 to 12)
- Usable in 100 % water and buffer solution
- Fulfills USP-NF L1 requirements

### • Semi-micro columns

Product Code	Product Name	Functional Group	Particle Size (µm)	*Carbon Load (%)	Pore Size (Å)	Column Size (mm) I.D. x Length	Shipping Solvent
F6654011	<b>C18U 2B</b>	Octadecyl	1.9	20	120	<b>2.0 x 50</b>	CH <sub>3</sub> CN
F6654012	<b>C18U 2D</b>	Octadecyl	1.9	20	120	<b>2.0 x 150</b>	CH <sub>3</sub> CN

\* Includes carbon in hybrid silica base material (8%).

Base Material: Organic/inorganic hybrid silica

## Aflatoxins

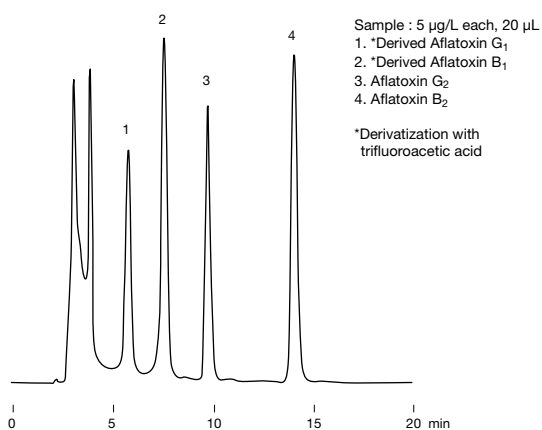

**Column** : Shodex Silica C18M 4E  
 Eluent : H<sub>2</sub>O/CH<sub>3</sub>CN/CH<sub>3</sub>OH = 60/10/30  
 Flow rate : 1.0 mL/min  
 Detector : Fluorescence (Ex. : 365 nm, Em. : 450 nm)  
 Column temp. : 40 °C

## Mycotoxins of trichothecene type

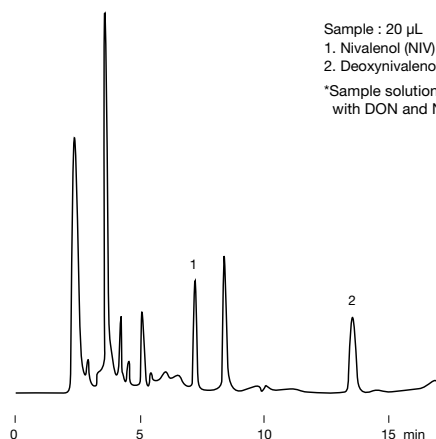

**Column** : Shodex Silica C18M 4E  
 Eluent : H<sub>2</sub>O/CH<sub>3</sub>CN/CH<sub>3</sub>OH = 90/5/5  
 Flow rate : 1.0 mL/min  
 Detector : UV (220 nm)  
 Column temp. : 40 °C

## Gingerol and shogaol

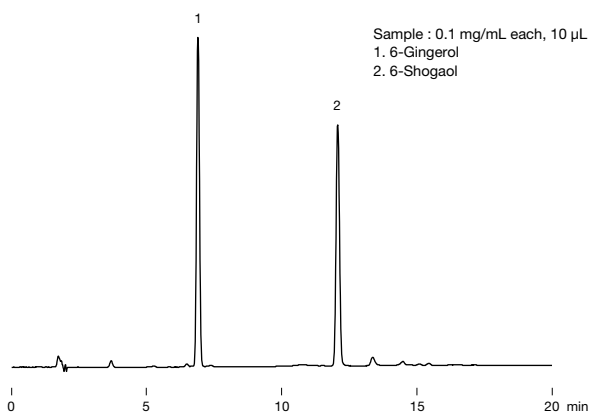

**Column** : Shodex Silica C18M 4D  
 Eluent : (A); H<sub>2</sub>O/(B); CH<sub>3</sub>CN  
 Linear gradient; 40 B % to 70 B % (15 min)  
 Flow rate : 1.0 mL/min  
 Detector : UV (280 nm)  
 Column temp. : 40 °C

## LC/MS/MS simultaneous analysis of aflatoxins

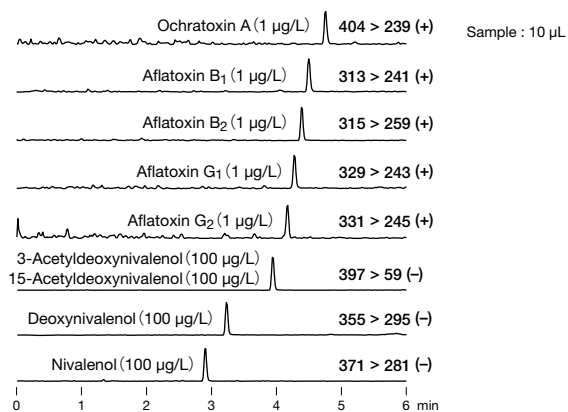

**Column** : Shodex C18U 2B  
 Eluent : (A); 10 mM CH<sub>3</sub>COONH<sub>4</sub> aq. / (B); CH<sub>3</sub>OH  
 Gradient;  
 0 to 90 B % (0 to 5 min), 90 B % (5 to 7 min), 0 B % (7.01 to 10 min),  
 0 B % (7.01 to 10 min)  
 Flow rate : 0.4 mL/min  
 Detector : ESI-MS/MS (MRM)  
 Column temp. : 40 °C

## Tryptic digests of rituximab

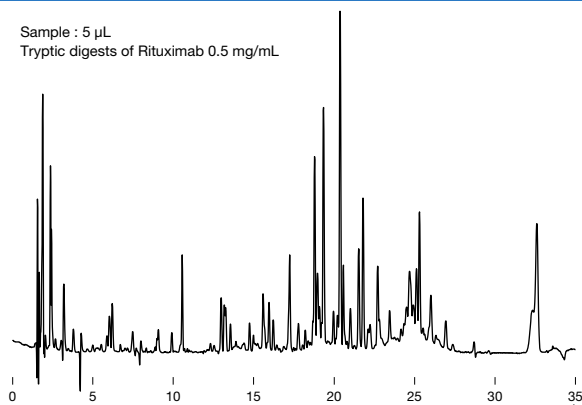

**Column** : Shodex C18U 2D  
 Eluent : (A); 0.1 % TFA in H<sub>2</sub>O/(B); 0.1 % TFA in CH<sub>3</sub>CN  
 Linear gradient;  
 10 to 40 B % (0 to 25 min), 40 B % (25 to 30 min),  
 90 B % (30 to 35 min)  
 Flow rate : 0.2 mL/min  
 Detector : UV (220 nm)  
 Column temp. : 40 °C

## LC/MS simultaneous analysis of macrolide antibiotics

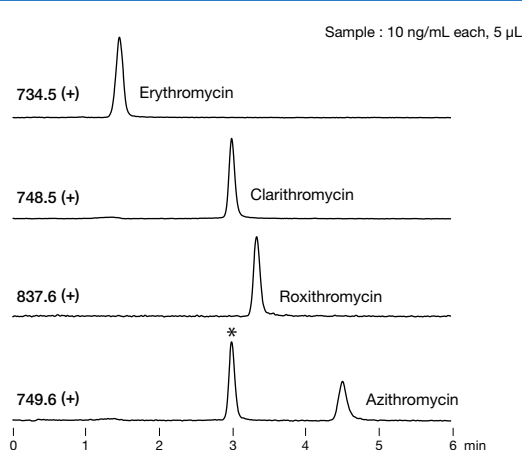

**Column** : Shodex C18U 2B  
 Eluent : 0.05 % NH<sub>3</sub> aq./CH<sub>3</sub>CN = 40/60  
 Flow rate : 0.4 mL/min  
 Detector : ESI-MS (SIM)  
 Column temp. : 40 °C

\*: Clarithromycin containing one <sup>13</sup>C isotope

# Ligand Exchange Chromatography Columns

\* Please check our website for elution-volume summary lists of various saccharides using Shodex columns.

## Features

### SC1011

### SP0810

### KS-801

### KS-802

- Separates saccharides by combination of ligand exchange and size exclusion modes
- Three types of counter ions are available: Ca<sup>2+</sup>, Pb<sup>2+</sup> and Na<sup>+</sup>
- Only water is required for the analysis of neutral sugars
- SC1011 fulfills USP-NF L19 and L22 requirements
- SP0810 fulfills USP-NF L22 and L34 requirements
- KS-801 and KS-802 fulfill USP-NF L22 and L58 requirements

### KS-803

### KS-804

- Suitable for separation of polysaccharides by size exclusion mode
- Can be used in combination with other columns e.g., KS-801 and/or KS-802
- Only water is required for the analysis of neutral sugars
- Fulfill USP-NF L22 and L58 requirements

### DC-613

### SZ5532

### SC1211

- Separates elements by combination of ligand exchange and HILIC modes
- DC-613 can analyze sugars without removing sodium salts in the sample
- SZ5532 is recommended for the separation of disaccharides or trisaccharides
- SC1211 is suitable for separating sugar alcohols
- DC-613 fulfills USP-NF L22 and L58 requirements
- SZ5532 fulfills USP-NF L22 requirements
- SC1211 fulfills USP-NF L19 and L22 requirements

### SC1011-7F

### MN-431

- Pharmacopoeia method relevant columns
- Ca<sup>2+</sup> modified ligand exchange chromatography column
- Only water is required for the analysis of neutral sugars
- Fulfill USP-NF L19 and L22 requirements

## Ligand exchange and size exclusion

### Standard columns

Product Code	Product Name	Plate Number (TP/column)	Functional Group (Counter Ion)	Exclusion Limit (Pullulan)	Particle Size (µm)	Column Size (mm) I.D. x Length	Shipping Solvent
F6378102	<b>SUGAR SC1011</b>	≥ 13,000	Sulfo (Ca <sup>2+</sup> )	1,000	6	<b>8.0 x 300</b>	H <sub>2</sub> O
F6700090	<b>SUGAR SC-G 6B</b>	(guard column)	Sulfo (Ca <sup>2+</sup> )	—	10	<b>6.0 x 50</b>	H <sub>2</sub> O
F6378105	<b>SUGAR SP0810</b>	≥ 11,000	Sulfo (Pb <sup>2+</sup> )	1,000	7	<b>8.0 x 300</b>	H <sub>2</sub> O
F6700081	<b>SUGAR SP-G 6B</b>	(guard column)	Sulfo (Pb <sup>2+</sup> )	—	10	<b>6.0 x 50</b>	H <sub>2</sub> O
F6378106	<b>SUGAR SP0810 8C</b>	≥ 3,000	Sulfo (Pb <sup>2+</sup> )	1,000	7	<b>8.0 x 100</b>	H <sub>2</sub> O
F6378010	<b>SUGAR KS-801</b>	≥ 17,000	Sulfo (Na <sup>+</sup> )	1,000	6	<b>8.0 x 300</b>	H <sub>2</sub> O
F6378020	<b>SUGAR KS-802</b>	≥ 17,000	Sulfo (Na <sup>+</sup> )	10,000	6	<b>8.0 x 300</b>	H <sub>2</sub> O
F6378025	<b>SUGAR KS-803</b>	≥ 17,000	Sulfo (Na <sup>+</sup> )	50,000	6	<b>8.0 x 300</b>	H <sub>2</sub> O
F6378035	<b>SUGAR KS-804</b>	≥ 17,000	Sulfo (Na <sup>+</sup> )	400,000	7	<b>8.0 x 300</b>	H <sub>2</sub> O
F6700020	<b>SUGAR KS-G 6B</b>	(guard column)	Sulfo (Na <sup>+</sup> )	—	10	<b>6.0 x 50</b>	H <sub>2</sub> O

Base Material: Styrene divinylbenzene copolymer

## Ligand exchange and HILIC

### Standard columns

Product Code	Product Name	Plate Number (TP/column)	Functional Group (Counter Ion)	Particle Size (µm)	Pore Size (Å)	Column Size (mm) I.D. x Length	Shipping Solvent
F7001003	<b>RSpak DC-613</b>	≥ 5,500	Sulfo (Na <sup>+</sup> )	6	100	<b>6.0 x 150</b>	H <sub>2</sub> O/CH <sub>3</sub> CN = 30/70
F6700170	<b>RSpak DC-G 4A</b>	(guard column)	Sulfo (Na <sup>+</sup> )	10	—	<b>4.6 x 10</b>	H <sub>2</sub> O/CH <sub>3</sub> CN = 30/70
F7001300	<b>SUGAR SZ5532</b>	≥ 5,500	Sulfo (Zn <sup>2+</sup> )	6	—	<b>6.0 x 150</b>	H <sub>2</sub> O/CH <sub>3</sub> CN = 30/70
F6700110	<b>SUGAR SZ-G</b>	(guard column)	Sulfo (Zn <sup>2+</sup> )	6	—	<b>4.6 x 10</b>	H <sub>2</sub> O/CH <sub>3</sub> CN = 30/70
F7001400	<b>SUGAR SC1211</b>	≥ 5,500	Sulfo (Ca <sup>2+</sup> )	6	50	<b>6.0 x 250</b>	H <sub>2</sub> O/CH <sub>3</sub> CN = 75/25
F6700120	<b>SUGAR SC1211G 4A</b>	(guard column)	Sulfo (Ca <sup>2+</sup> )	10	—	<b>4.6 x 10</b>	H <sub>2</sub> O/CH <sub>3</sub> CN = 75/25

Base Material: Styrene divinylbenzene copolymer



## Pharmacopoeia Method Relevant Columns

## ● Standard columns

Product Code	Product Name	Plate Number (TP/column)	Functional Group (Counter Ion)	Particle Size (µm)	Column Size (mm) I.D. x Length	Shipping Solvent
F6379300	<b>EP SC1011-7F</b>	≥ 13,000	Sulfo (Ca <sup>2+</sup> )	8	<b>7.8 x 300</b>	H <sub>2</sub> O
F6700090	<b>SUGAR SC-G 6B</b>	(guard column)	Sulfo (Ca <sup>2+</sup> )	10	<b>6.0 x 50</b>	H <sub>2</sub> O
F6379230	<b>USPpak MN-431</b>	≥ 4,000	Sulfo (Ca <sup>2+</sup> )	8	<b>4.0 x 250</b>	H <sub>2</sub> O

See page 72 for USP-NF Column List.

Base Material: Styrene divinylbenzene copolymer

### A partial list of saccharide elution volumes analyzed by Shodex columns (Refer to our website for the complete list)

Substance	Elution volume (mL)						
	SP0810	SC1011	KS-801	SZ5532	SC1211	NH2P-50 4E	VG-50 4E
Arabinose	10.42	8.91	8.21	5.11	5.56	6.18	5.65
D-Arabitol	15.86	11.33	7.63	7.27	8.16	6.29	6.05
Dulcitol	20.18	12.76	7.40	9.46	11.28	7.45	N/A
meso-Erythritol	12.70	10.09	7.86	5.73	6.27	5.43	5.10
D(-)-Fructose	11.05	8.85	7.71	5.37	5.90	6.75	6.19
D(+)-Fucose	10.48	8.84	8.09	4.50	4.96	5.43	5.06
D(+)-Galactose	9.74	7.98	7.58	6.46	4.98	8.10	7.37
Gentiobiose	7.22	6.08	5.75	10.50	*	16.36	14.52
Glucose	8.63	7.30	7.17	5.87	4.76	8.61	7.47
myo-Inositol	12.77	8.86	7.99	12.63	7.87	9.96	11.68
Isomaltose	7.68	6.26	5.95	10.57	*	15.18	14.41
Isomaltotriose	7.09	5.75	5.34	21.17	*	27.55	N/A
1-Kestose	6.79	5.75	5.26	13.09	*	20.11	N/A
Kojibiose	7.56	6.21	5.88	9.65	*	14.82	N/A
Lactitol	13.27	8.09	6.13	16.35	6.67	11.82	13.28
Lactose	8.05	6.51	5.99	10.12	4.07	13.27	12.46
Lactulose	9.13	6.99	6.19	9.16	4.65	10.72	10.52
Maltitol	12.23	8.26	6.03	13.04	6.77	11.82	12.37
Maltose	7.85	6.34	5.94	8.67	*	14.24	12.71
Maltotriose	7.48	5.89	5.38	13.79	*	24.96	N/A
Mannitol	15.80	11.10	7.23	8.75	9.03	7.39	7.35
D-Mannose	10.72	8.17	7.64	5.83	5.01	7.84	6.95
Melibiose	8.16	6.45	5.98	11.69	4.23	14.70	15.07
Nystose	6.38	5.45	4.93	20.05	*	31.90	N/A
Palatinin	2 peaks	2 peaks	5.90	2 peaks	2 peaks	12.73	14.23
Palatinose	7.84	6.45	5.89	8.08	3.99	12.12	11.26
Panose	7.14	5.78	5.32	16.87	*	25.60	N/A
D(+)-Raffinose	7.14	5.78	5.29	16.36	*	20.25	N/A
Rhamnose	9.77	8.23	7.37	3.93	4.43	5.52	4.87
D(-)-Ribose	19.35	13.66	9.04	4.82	8.64	5.45	4.93
D(-)-Sorbitol	21.61	13.31	7.42	9.79	11.88	7.09	7.18
Sorbose	9.67	8.03	7.38	5.12	4.92	7.35	6.79
Stachyose	6.82	5.57	4.97	—	*	36.22	N/A
Sucrose	7.54	6.29	5.87	7.91	*	11.87	10.69
α-D-Talose	21.33	12.59	8.76	5.69	8.51	6.47	5.75
Trehalose	7.62	6.27	5.78	10.85	*	13.25	14.36
Trehalulose	8.92	6.95	6.10	9.54	4.78	11.68	11.92
Xylitol	19.87	13.14	7.94	7.77	10.16	6.10	6.04
Xylobiose	8.16	6.68	6.40	5.65	*	9.05	7.83
D(+)-Xylose	9.21	7.90	7.71	4.55	4.48	6.58	5.78
D-Xylulose	10.64	9.02	8.04	4.06	5.07	5.41	N/A

N/A: Data not available (—): Not detected (\*): Overlap with solvent peak

**Column : SUGAR SP0810, SC1011, KS-801**  
 Eluent : H<sub>2</sub>O  
 Flow rate : 1.0 mL/min  
 Detector : RI  
 Column temp. : 80 °C

**Column : SUGAR SZ5532**  
 Eluent : H<sub>2</sub>O/CH<sub>3</sub>CN= 25/75  
 Flow rate : 1.0 mL/min  
 Detector : RI  
 Column temp. : 60 °C

**Column : SUGAR SC1211**  
 Eluent : H<sub>2</sub>O/CH<sub>3</sub>CN= 65/35  
 Flow rate : 1.0 mL/min  
 Detector : RI  
 Column temp. : 70 °C

**Column : Asahipak NH2P-50 4E**  
 Eluent : H<sub>2</sub>O/CH<sub>3</sub>CN= 25/75  
 Flow rate : 1.0 mL/min  
 Detector : RI  
 Column temp. : 30 °C

**Column : HILICpak VG-50 4E**  
 Eluent : H<sub>2</sub>O/CH<sub>3</sub>CN= 20/80  
 Flow rate : 1.0 mL/min  
 Detector : RI  
 Column temp. : 40 °C

### Saccharides anomer separation

Saccharides may present their anomers at lower temperatures. By setting the SUGAR series columns at higher temperatures will prevent the anomer separation and this results in providing better chromatograms of each saccharide.

Sample : 0.5 % each, 10  $\mu$ L

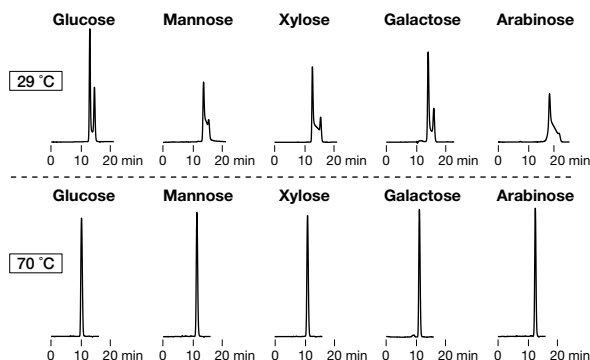

**Column** : Shodex SUGAR SC1011  
 Eluent : H<sub>2</sub>O  
 Flow rate : 0.7 mL/min  
 Detector : RI  
 Column temp. : 29 °C, 70 °C

### Calibration curves for KS-800 series using pullulan

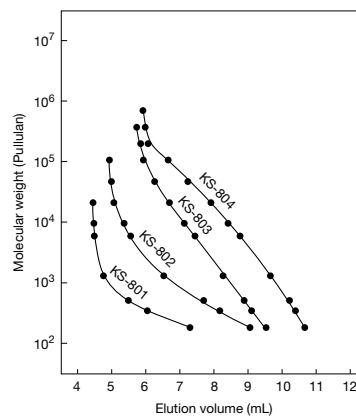

**Column** : Shodex SUGAR KS-800 series  
 Eluent : H<sub>2</sub>O  
 Detector : RI  
 Column temp. : 80 °C

### Hydrolyzed starch

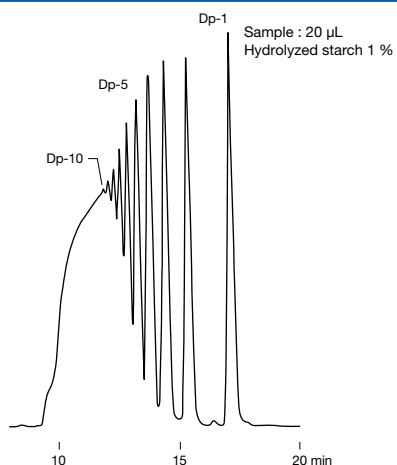

**Column** : Shodex SUGAR KS-802 x 2  
 Eluent : H<sub>2</sub>O  
 Flow rate : 1.0 mL/min  
 Detector : RI  
 Column temp. : 80 °C

### Biomass sugars

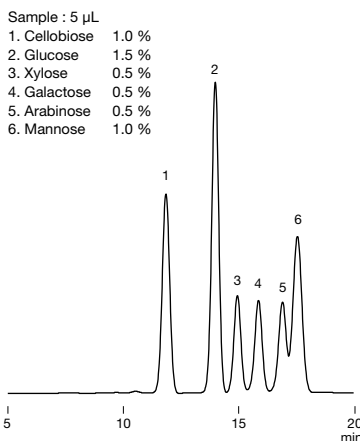

Sample : 5  $\mu$ L  
 1. Cellobiose 1.0 %  
 2. Glucose 1.5 %  
 3. Xylose 0.5 %  
 4. Galactose 0.5 %  
 5. Arabinose 0.5 %  
 6. Mannose 1.0 %

**Column** : Shodex SUGAR SP0810  
 Eluent : H<sub>2</sub>O  
 Flow rate : 0.6 mL/min  
 Detector : RI  
 Column temp. : 85 °C

### Pinitol

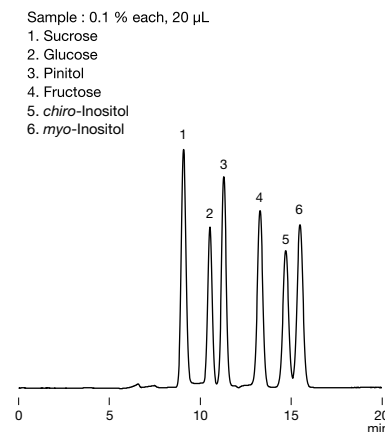

Sample : 0.1 % each, 20  $\mu$ L  
 1. Sucrose  
 2. Glucose  
 3. Pinitol  
 4. Fructose  
 5. *chiro*-Inositol  
 6. *myo*-Inositol

**Column** : Shodex SUGAR SP0810  
 Eluent : H<sub>2</sub>O  
 Flow rate : 0.8 mL/min  
 Detector : RI  
 Column temp. : 85 °C

### Analysis of sorbitol according to USP-NF method

Sample : 10  $\mu$ L  
 (System suitability solution) Mannitol, Sorbitol 4.8 mg/g each  
 (Standard solution) Sorbitol 4.8 mg/g

1. Mannitol  
 2. Sorbitol

**System suitability solution**

**Standard solution**

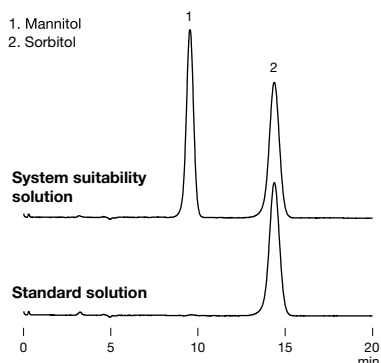

**Column** : Shodex SUGAR SP0810 8C  
 Eluent : H<sub>2</sub>O  
 Flow rate : 0.7 mL/min  
 Detector : RI (35 °C)  
 Column temp. : 50 °C

### Oligosaccharides in soybean

Sample : 0.1 % each, 20  $\mu$ L  
 1. Verbascose  
 2. Stachyose  
 3. Raffinose  
 4. Sucrose  
 5. Pinitol

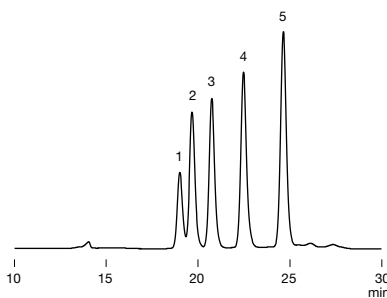

**Column** : Shodex SUGAR KS-802 + KS-801  
 Eluent : H<sub>2</sub>O  
 Flow rate : 0.6 mL/min  
 Detector : RI  
 Column temp. : 85 °C

### Saccharides related to raffinose biosynthesis

Sample : 0.1 % each, 20  $\mu$ L  
 1. Verbascose  
 2. Sucrose  
 3. Galactinol  
 4. Galactose  
 5. *myo*-Inositol

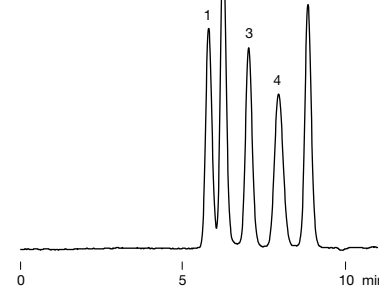

**Column** : Shodex SUGAR SC1011  
 Eluent : H<sub>2</sub>O  
 Flow rate : 1.0 mL/min  
 Detector : RI  
 Column temp. : 80 °C

### Acesulfame K and sucralose

Sample : 20  $\mu$ L  
 1. Acesulfame K 0.1 %  
 2. Sucrose 0.5 %  
 3. Glucose 0.5 %  
 4. Unknown from Acesulfame K  
 5. Fructose 0.5 %  
 6. Sucralose 0.1 %

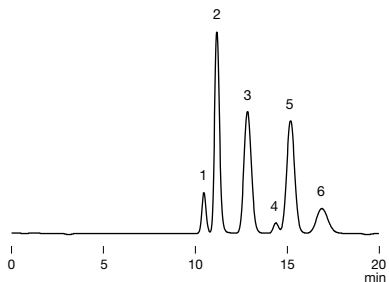

Column : Shodex SUGAR SC1011  
 Eluent : 10 mM CaSO<sub>4</sub> aq.  
 Flow rate : 0.6 mL/min  
 Detector : RI  
 Column temp. : 80 °C

### Sucrose and turanose

Sample : 0.5 % each, 10  $\mu$ L  
 1. Fructose  
 2. Glucose  
 3. Sucrose  
 4. Turanose  
 5. Lactose

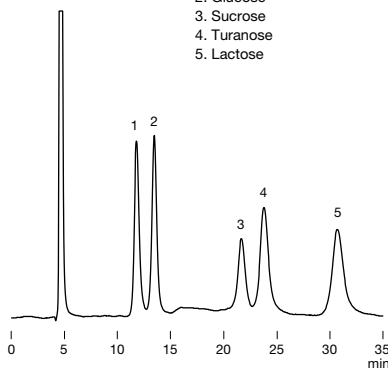

Column : Shodex SUGAR SZ5532  
 Eluent : H<sub>2</sub>O/CH<sub>3</sub>CN = 20/80  
 Flow rate : 0.6 mL/min  
 Detector : RI  
 Column temp. : 60 °C

### Maltose and isomaltose

Sample : 0.5 % each, 20  $\mu$ L  
 1. Glucose  
 2. Maltose  
 3. Isomaltose  
 4. Maltotriose  
 5. Isomaltotriose

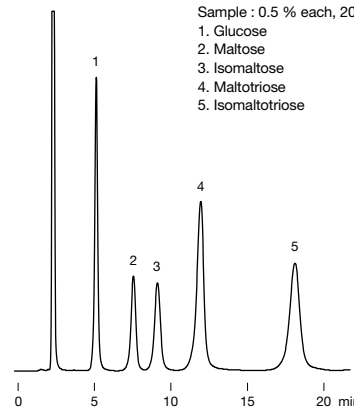

Column : Shodex SUGAR SZ5532  
 Eluent : H<sub>2</sub>O/CH<sub>3</sub>CN = 25/75  
 Flow rate : 1.0 mL/min  
 Detector : RI  
 Column temp. : 60 °C

### Saccharides and sugar alcohols

Sample : 0.5 % each, 20  $\mu$ L  
 1. Rhamnose  
 2. Xylose  
 3. Arabinose  
 4. Fructose  
 5. Glucose  
 6. Galactose  
 7. Arabitol  
 8. Xylitol  
 9. Mannitol  
 10. Sorbitol

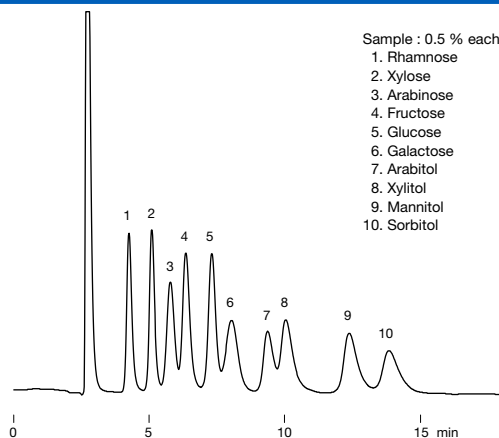

Column : Shodex SUGAR SZ5532  
 Eluent : H<sub>2</sub>O/CH<sub>3</sub>CN = 20/80  
 Flow rate : 1.0 mL/min  
 Detector : RI  
 Column temp. : 65 °C

### Saccharides and taurine

Sample : 0.1 % each, 20  $\mu$ L  
 1. Sucrose  
 2. Glucose  
 3. Fructose  
 4. Taurine  
 5. *myo*-Inositol

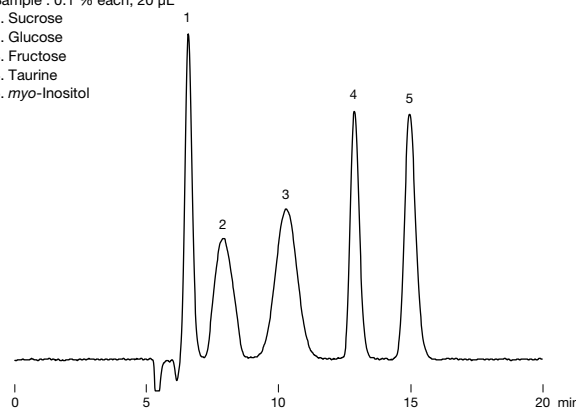

Column : Shodex SUGAR SC1211  
 Eluent : H<sub>2</sub>O/CH<sub>3</sub>CN = 60/40  
 Flow rate : 0.6 mL/min  
 Detector : RI  
 Column temp. : 70 °C

### Moisturizing components

Sample : 0.1 % each, 20  $\mu$ L  
 1. 1,3-Propanediol  
 2. Propylene glycol  
 3. Ethylene glycol  
 4. Glycerin  
 5. *meso*-Erythritol

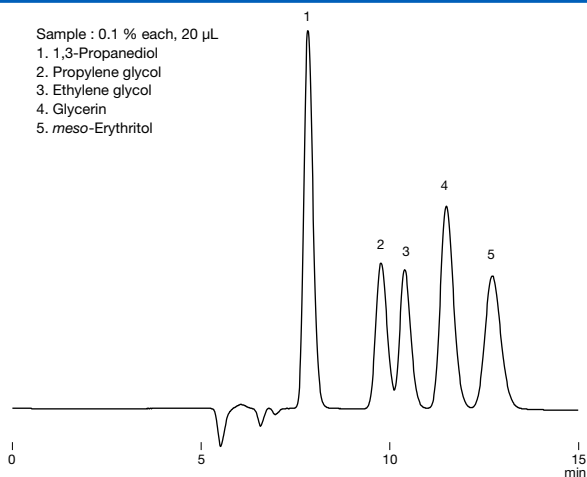

Column : Shodex SUGAR SC1211  
 Eluent : H<sub>2</sub>O/CH<sub>3</sub>CN = 60/40  
 Flow rate : 0.6 mL/min  
 Detector : RI  
 Column temp. : 40 °C

### Analysis of mannitol according to Pharmacopeias (JP, USP and EP)

Sample : 25 mg/mL each, 20  $\mu$ L  
 1. Mannitol  
 2. Sorbitol

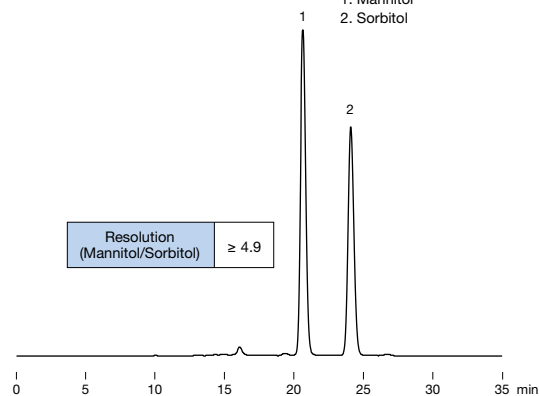

Column : Shodex EP SC1011-7F  
 Eluent : H<sub>2</sub>O  
 Flow rate : 0.5 mL/min  
 Detector : RI  
 Column temp. : 85 °C

# Ion Exclusion Chromatography Columns

## Features

### SH1011 SH1821

- Columns for simultaneous analysis of saccharides and organic acids (counter ion: H<sup>+</sup>)
- Separates neutral sugars by size exclusion mode and organic acids by ion exclusion mode
- Suitable for the analysis of uronic and aldonic acids
- Fulfill USP-NF L17 and L22 requirements

### KC-811

- Columns suitable for the analysis of organic acids
- Separates compounds by ion exclusion mode and reversed phase mode
- Highly selective when used with post column method
- KC-811 6E is suitable for cyanide ions and cyanogen chloride analysis in accordance with the Japanese Water Supply Act
- Fulfills USP-NF L17 and L22 requirements

### For simultaneous analysis of saccharides and organic acids

#### • Standard columns

Product Code	Product Name	Plate Number (TP/column)	Functional Group	Exclusion Limit (Pullulan)	Particle Size (µm)	Column Size (mm) I.D. x Length	Shipping Solvent
F6378100	<b>SUGAR SH1011</b>	≥ 17,000	Sulfo	1,000	6	<b>8.0 x 300</b>	H <sub>2</sub> O
F6378101	<b>SUGAR SH1821</b>	≥ 17,000	Sulfo	10,000	6	<b>8.0 x 300</b>	H <sub>2</sub> O
F6700080	<b>SUGAR SH-G</b>	(guard column)	Sulfo	—	10	<b>6.0 x 50</b>	H <sub>2</sub> O
F6378104	<b>SUGAR SH1011 8C</b>	≥ 5,000	Sulfo	1,000	6	<b>8.0 x 100</b>	H <sub>2</sub> O

Base Material: Styrene divinylbenzene copolymer

### For organic acids, cyanide ions and cyanogen chloride

#### • Standard columns

Product Code	Product Name	Plate Number (TP/column)	Functional Group	Particle Size (µm)	Column Size (mm) I.D. x Length	Shipping Solvent
F6378030	<b>RSpak KC-811</b>	≥ 17,000	Sulfo	6	<b>8.0 x 300</b>	0.1 % H <sub>3</sub> PO <sub>4</sub> aq.
F6378033	<b>RSpak KC-811 6E</b>	≥ 13,000	Sulfo	6	<b>6.0 x 250</b>	0.1 % H <sub>3</sub> PO <sub>4</sub> aq.
F6700030	<b>RSpak KC-G 6B</b>	(guard column)	Sulfo	10	<b>6.0 x 50</b>	0.1 % H <sub>3</sub> PO <sub>4</sub> aq.
F6700010	<b>RSpak KC-G 8B</b>	(guard column)	Sulfo	13	<b>8.0 x 50</b>	0.1 % H <sub>3</sub> PO <sub>4</sub> aq.

Use KC-G 8B for samples with relatively high impurities and KC-G 6B for samples with relatively low impurities.

Base Material: Styrene divinylbenzene copolymer

### Maltooligosaccharides, organic acids and ethanol

Sample : 0.05 % each, 20  $\mu$ L  
 1. Maltotetraose  
 2. Maltotriose  
 3. Maltose  
 4. Glucose  
 5. Lactic acid  
 6. Glycerin  
 7. Acetic acid  
 8. Methanol  
 9. Ethanol

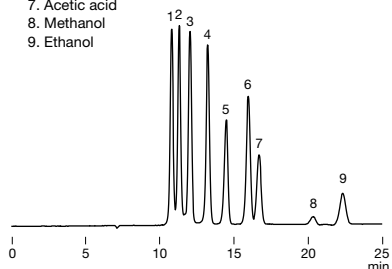

**Column** : Shodex SUGAR SH1821  
**Eluent** : 0.5 mM H<sub>2</sub>SO<sub>4</sub> aq.  
**Flow rate** : 0.6 mL/min  
**Detector** : RI  
**Column temp.** : 75 °C

### Cello-oligosaccharides and furfurals

Sample : 0.1 % each, 10  $\mu$ L  
 1. Cellopentaose  
 2. Cellotetraose  
 3. Cellotriose  
 4. Cellobiose  
 5. Glucose  
 6. Glyceric acid  
 7. Acetic acid  
 8. 5-HMF  
 9. Furfural

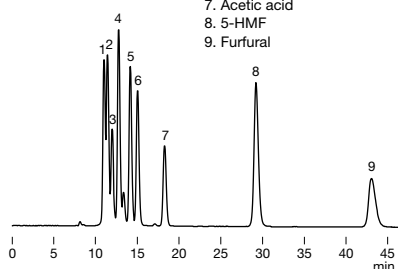

**Column** : Shodex SUGAR SH1821  
**Eluent** : 2 mM H<sub>2</sub>SO<sub>4</sub> aq.  
**Flow rate** : 0.6 mL/min  
**Detector** : RI  
**Column temp.** : 60 °C

### Glycerin and glyceric acid

Sample : 0.1 % each, 10  $\mu$ L  
 1. Glyceric acid  
 2. Glycerin

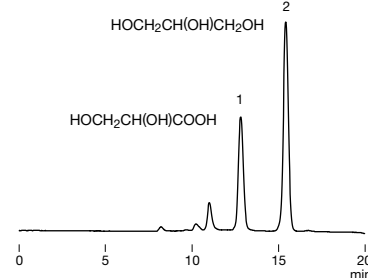

**Column** : Shodex SUGAR SH1011  
**Eluent** : 2 mM H<sub>2</sub>SO<sub>4</sub> aq.  
**Flow rate** : 0.6 mL/min  
**Detector** : RI  
**Column temp.** : 60 °C

### Rapid analysis of maltooligosaccharides, organic acids and ethanol

Sample : 0.1 % each, 5  $\mu$ L  
 1. Maltotriose  
 2. Maltose  
 3. Glucose  
 4. Lactic acid  
 5. Acetic acid  
 6. Glycerin  
 7. Ethanol

**(1) Shodex SUGAR SH1011 8C (8.0 mm I.D. x 100 mm)**

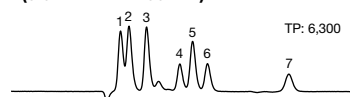

**(2) Ion exclusion column from other manufacturer (7.8 mm I.D. x 100 mm)**

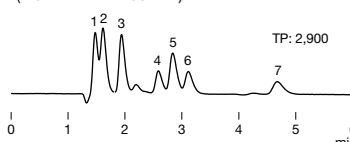

**Column** : (1) Shodex SUGAR SH1011 8C  
 (2) Ion exclusion column from other manufacturer  
**Eluent** : 1 mM H<sub>2</sub>SO<sub>4</sub> aq.  
**Flow rate** : (1) 1.0 mL/min  
 (2) 0.95 mL/min  
**Detector** : RI  
**Column temp.** : 65 °C

### Common organic acids

Sample :

1. Citric acid  
 2. Tartaric acid  
 3. Pyruvic acid  
 4. Malic acid  
 5. Succinic acid  
 6. Glycolic acid  
 7. Lactic acid  
 8. Fumaric acid  
 9. Acetic acid  
 10. Levulinic acid  
 11. Pyroglutamic acid  
 12. Propionic acid  
 13. Isobutyric acid  
 14. n-Butyric acid

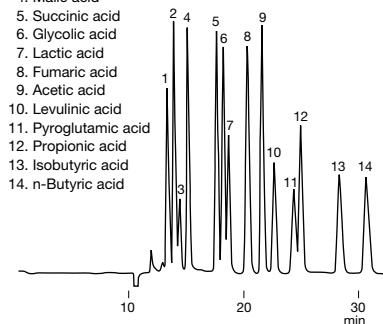

**Column** : Shodex RSpak KC-811 x 2  
**Eluent** : 6 mM HClO<sub>4</sub> aq.  
**Flow rate** : 1.0 mL/min  
**Detector** : VIS (430 nm)  
 post column method  
**Column temp.** : 50 °C

### Glucuronolactone and organic acids

Sample : 20  $\mu$ L  
 1. Citric acid 0.01 %  
 2. Malic acid 0.01 %  
 3. Glucuronolactone 0.01 %  
 4. Glycerin 0.01 %  
 5. Ethanol 0.05 %

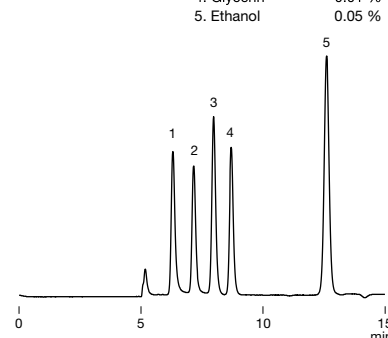

**Column** : Shodex RSpak KC-811  
**Eluent** : 3 mM HClO<sub>4</sub> aq.  
**Flow rate** : 1.0 mL/min  
**Detector** : RI  
**Column temp.** : 40 °C

### Organic acids in sake

Sample : 100  $\mu$ L

1. Phosphoric acid etc.  
 2. Citric acid  
 3. Pyruvic acid  
 4. Malic acid  
 5. Succinic acid  
 6. Lactic acid  
 7. Fumaric acid  
 8. Acetic acid  
 9. Pyroglutamic acid

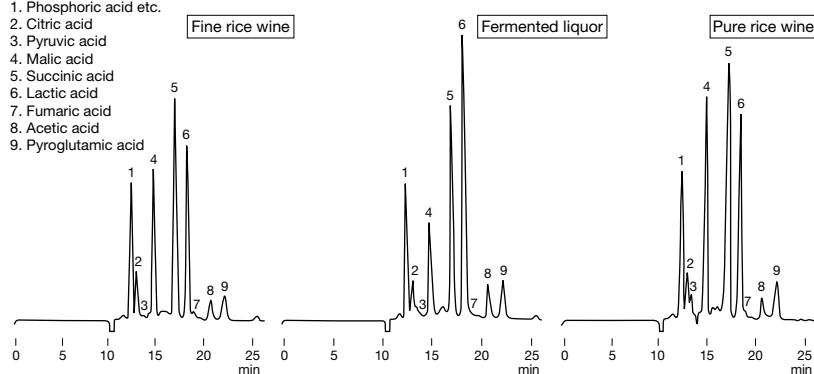

**Column** : Shodex RSpak KC-G 8B + KC-811 x 2  
**Eluent** : 4.8 mM HClO<sub>4</sub> aq.  
**Flow rate** : 1.0 mL/min  
**Detector** : VIS (430 nm)  
 post column method  
**Column temp.** : 63 °C

### Analysis of cyanide ion and cyanogen chloride with post column method

Sample : 10  $\mu$ g/L each, 100  $\mu$ L

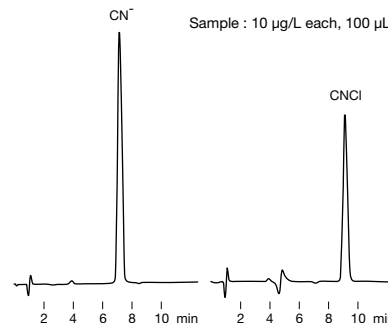

**Column** : Shodex RSpak KC-811 6E  
**Eluent** : 1 mM H<sub>2</sub>SO<sub>4</sub> aq.  
**Reagent A** : Chloramine T solution  
**Reagent B** : 4-Pyridinecarboxylic acid-Pyrazolone solution  
**Flow rate** : (Eluent) 1.0 mL/min  
 (Reagent) 0.5 mL/min each  
**Detector** : VIS (638 nm)  
**Column temp.** : 40 °C  
**Reaction temp.** : (Reagent A) 40 °C  
 (Reagent B) 80 °C

# Ion Chromatography Columns (Anion Analysis)

## Features

- |   |  |
|---|--|
| <b>NI-424</b><br><b>I-524A</b>                        | <ul style="list-style-type: none"> <li>• Ideal for anion non-suppressor methods</li> <li>• NI-424 provides simultaneous analysis of fluoride and phosphate ions</li> <li>• I-524A fulfills USP-NF L23 requirements</li> </ul>  |
| <b>SI-90 4E</b><br><b>SI-50 4E</b><br><b>SI-52 4E</b> | <ul style="list-style-type: none"> <li>• Suitable for anion suppressor methods with sodium carbonate eluent</li> <li>• Suitable for the quantitative analysis of fluoride ion</li> <li>• Carbonate peak does not interfere with analysis</li> <li>• SI-50 4E separates target inorganic anions from organic acids</li> <li>• SI-52 4E provides simultaneous analysis of oxyhalides and general inorganic ions</li> </ul> |
| <b>SI-35</b>  | <ul style="list-style-type: none"> <li>• Rapid-analysis type columns used with suppressor and sodium carbonate eluent</li> <li>• SI-35 4D provides rapid analysis of oxyhalides and general inorganic ions</li> <li>• SI-35 2B provides rapid analysis of general inorganic ions</li> </ul>  |
| <b>SI-36 4D</b><br><b>SI-37 4D</b>                    | <ul style="list-style-type: none"> <li>• Suitable for anion suppressor methods with potassium hydroxide eluent</li> <li>• SI-36 4D provides good separation of sulfite and sulfate ions</li> <li>• SI-37 4D provides high sensitive analysis of oxyhalides in drinking water</li> </ul>  |

### For non-suppressor method

#### • Standard columns

Product Code	Product Name	Plate Number (TP/column)	Functional Group	Particle Size (µm)	Column Size (mm) I.D. x Length	Shipping Solvent
F6995243	<b>IC NI-424</b>	≥ 5,000	Quaternary ammonium	5	<b>4.6 x 100</b>	8 mM 4-Hydroxybenzoic acid + 2.8 mM Bis-Tris + 2 mM Phenylboronic acid + 0.005 mM CyDTA aq.
F6709616	<b>IC NI-G</b>	(guard column)	Quaternary ammonium	5	<b>4.6 x 10</b>	8 mM 4-Hydroxybenzoic acid + 2.8 mM Bis-Tris + 2 mM Phenylboronic acid + 0.005 mM CyDTA aq.
F6995240	<b>IC I-524A</b>	≥ 2,000	Quaternary ammonium	12	<b>4.6 x 100</b>	2.5 mM Phthalic acid + 2.4 mM Tris(hydroxymethyl) aminomethane + 16.2 mM Boric acid aq.
F6700400	<b>IC IA-G</b>	(guard column)	Quaternary ammonium	12	<b>4.6 x 10</b>	2.5 mM Phthalic acid + 2.4 mM Tris(hydroxymethyl) aminomethane + 16.2 mM Boric acid aq.

Base Material: Polyhydroxymethacrylate  
Housing Material: SUS

### For suppressor method (Sodium carbonate eluent)

#### • Standard columns

Product Code	Product Name	Plate Number (TP/column)	Functional Group	Particle Size (µm)	Column Size (mm) I.D. x Length	Shipping Solvent
F6995244	<b>IC SI-90 4E</b>	≥ 5,000	Quaternary ammonium	9	<b>4.0 x 250</b>	1.8 mM Na <sub>2</sub> CO <sub>3</sub> + 1.7 mM NaHCO <sub>3</sub> aq.
F6709620	<b>IC SI-90G</b>	(guard column)	Quaternary ammonium	9	<b>4.6 x 10</b>	1.8 mM Na <sub>2</sub> CO <sub>3</sub> + 1.7 mM NaHCO <sub>3</sub> aq.
F6995245	<b>IC SI-50 4E</b>	≥ 10,000	Quaternary ammonium	5	<b>4.0 x 250</b>	3.2 mM Na <sub>2</sub> CO <sub>3</sub> + 1.0 mM NaHCO <sub>3</sub> aq.
F6709625	<b>IC SI-50G</b>	(guard column)	Quaternary ammonium	5	<b>4.6 x 10</b>	3.2 mM Na <sub>2</sub> CO <sub>3</sub> + 1.0 mM NaHCO <sub>3</sub> aq.

Base Material: Polyvinyl alcohol  
Housing Material: PEEK

### <For oxyhalides analysis>

Product Code	Product Name	Plate Number (TP/column)	Functional Group	Particle Size (µm)	Column Size (mm) I.D. x Length	Shipping Solvent
F6995260	<b>IC SI-52 4E</b>	≥ 14,000	Quaternary ammonium	5	<b>4.0 x 250</b>	3.6 mM Na <sub>2</sub> CO <sub>3</sub> aq.
F6709626	<b>IC SI-92G</b>	(guard column)	Quaternary ammonium	5	<b>4.6 x 10</b>	3.6 mM Na <sub>2</sub> CO <sub>3</sub> aq.

Base Material: Polyvinyl alcohol  
Housing Material: PEEK

### <For oxyhalides rapid analysis>

Product Code	Product Name	Plate Number (TP/column)	Functional Group	Particle Size (µm)	Column Size (mm) I.D. x Length	Shipping Solvent
F6995290	<b>IC SI-35 4D</b>	≥ 13,000	Quaternary ammonium	3.5	<b>4.0 x 150</b>	3.6 mM Na <sub>2</sub> CO <sub>3</sub> aq.
F6709627	<b>IC SI-95G</b>	(guard column)	Quaternary ammonium	9	<b>4.6 x 10</b>	3.6 mM Na <sub>2</sub> CO <sub>3</sub> aq.

Base Material: Polyvinyl alcohol  
Housing Material: PEEK

### ● Semi-micro column

<For rapid analysis>

Product Code	Product Name	Plate Number (TP/column)	Functional Group	Particle Size (μm)	Column Size (mm) I.D. x Length	Shipping Solvent
F6995291	<b>IC SI-35 2B</b>	≥ 4,000	Quaternary ammonium	3.5	<b>2.0 x 50</b>	1.0 mM Na <sub>2</sub> CO <sub>3</sub> + 2.0 mM NaHCO <sub>3</sub> aq.

Base Material: Polyvinyl alcohol  
Housing Material: PEEK

### ● Guard filter for IC SI-35 2B

Product Code	Product Name	Contents
F6709720	<b>IC SI-2GF</b>	One holder and one filter
F6709730	<b>IC SI-2GF filter</b>	3 filters

Removes sample-origin insoluble components.

For anion suppressor method (Potassium hydroxide eluent)

### ● Standard columns

Product Code	Product Name	Plate Number (TP/column)	Functional Group	Particle Size (μm)	Column Size (mm) I.D. x Length	Shipping Solvent
F6999361	<b>IC SI-36 4D</b>	≥ 8,500	Quaternary ammonium	3.5	<b>4.0 x 150</b>	10 mM Na <sub>2</sub> SO <sub>4</sub> aq.
F6999371	<b>IC SI-37 4D</b>	≥ 14,000	Quaternary ammonium	3.5	<b>4.0 x 150</b>	10 mM Na <sub>2</sub> SO <sub>4</sub> aq.
F6709620	<b>IC SI-90G</b>	(guard column)	Quaternary ammonium	9	<b>4.6 x 10</b>	1.8 mM Na <sub>2</sub> CO <sub>3</sub> + 1.7 mM NaHCO <sub>3</sub> aq.

Base Material: Polyvinyl alcohol  
Housing Material: PEEK

## Ion Chromatography Columns (Cation Analysis)

### Features

#### YS-50

- High performance type of YK-421
- Applicable to both suppressor and non-suppressor methods
- Provides sharp peaks; more significant for divalent cation analysis
- Supports the analysis of alkylamines and transition metals
- Fulfills USP-NF L125 requirements

#### YK-421

- Column for cation analysis with non-suppressor method
- Simultaneous analysis of monovalent and divalent cations
- Suitable separating alkylamines
- Fulfills USP-NF L76 requirements

For non-suppressor method/suppressor method

### ● Standard columns

Product Code	Product Name	Plate Number (TP/column)	Functional Group	Particle Size (μm)	Column Size (mm) I.D. x Length	Shipping Solvent
F7122000	<b>IC YS-50</b>	≥ 5,500	Carboxyl	5	<b>4.6 x 125</b>	10 mM Na <sub>2</sub> SO <sub>4</sub> aq.
F6700530	<b>IC YS-G</b>	(guard column)	Carboxyl	5	<b>4.6 x 10</b>	10 mM Na <sub>2</sub> SO <sub>4</sub> aq.

Base Material: Polyvinyl alcohol  
Housing Material: SUS

For non-suppressor method

### ● Standard columns

Product Code	Product Name	Plate Number (TP/column)	Functional Group	Particle Size (μm)	Column Size (mm) I.D. x Length	Shipping Solvent
F7120012	<b>IC YK-421</b>	≥ 2,800	Carboxyl	5	<b>4.6 x 125</b>	5 mM Tartaric acid + 1 mM Dipicolinic acid + 24 mM Boric acid aq.
F6709608	<b>IC YK-G</b>	(guard column)	Carboxyl	5	<b>4.6 x 10</b>	5 mM Tartaric acid + 1 mM Dipicolinic acid + 24 mM Boric acid aq.

Base Material: Silica  
Housing Material: SUS



## Anion analysis using NI-424 and I-524A (non-suppressor methods)

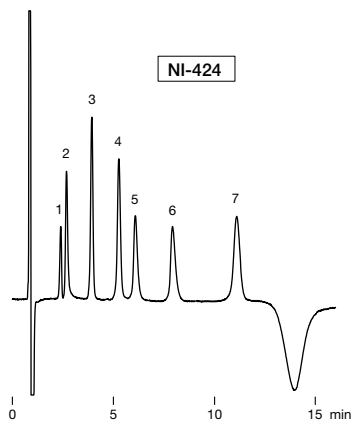

Sample : 20 µL  
 1. H<sub>2</sub>PO<sub>4</sub><sup>-</sup> 10 mg/L  
 2. F<sup>-</sup> 1 mg/L  
 3. Cl<sup>-</sup> 1 mg/L  
 4. NO<sub>2</sub><sup>-</sup> 5 mg/L  
 5. Br<sup>-</sup> 5 mg/L  
 6. NO<sub>3</sub><sup>-</sup> 5 mg/L  
 7. SO<sub>4</sub><sup>2-</sup> 5 mg/L

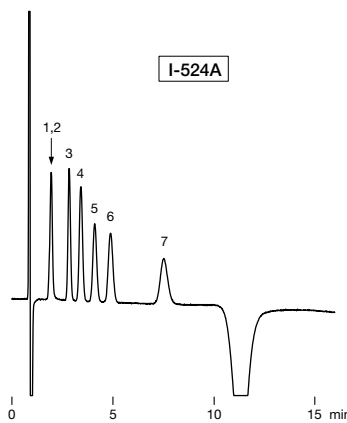

With twice increased theoretical plate number, NI-424 provides a higher performance compared to I-524A.

### <Features of NI-424>

- (1) Enables the separation of H<sub>2</sub>PO<sub>4</sub><sup>-</sup> and F<sup>-</sup> which were difficult to separate with I-524A.
- (2) Provides sharper peaks, and resolution between all peaks are well defined. Especially, the separation of Cl<sup>-</sup> and NO<sub>2</sub><sup>-</sup> is improved.

**Column** : Shodex IC NI-424  
**Eluent** : 8 mM 4-Hydroxybenzoic acid + 2.8 mM Bis-Tris + 2 mM Phenylboronic acid + 0.005 mM \*CyDTA aq.  
**Flow rate** : 1.0 mL/min  
**Detector** : Non-suppressed conductivity  
**Column temp.** : 40 °C

**Column** : Shodex IC I-524A  
**Eluent** : 2.5 mM Phthalic acid + 2.3 mM Tris(hydroxymethyl)aminomethane aq.  
**Flow rate** : 1.2 mL/min  
**Detector** : Non-suppressed conductivity  
**Column temp.** : 40 °C

\*CyDTA : trans-1,2-Diaminocyclohexane-N,N,N',N'-tetra acetic acid

### Anion analysis using SI-90 4E (suppressor method)

Sample : 20 µL  
 1. F<sup>-</sup> 2 mg/L  
 2. Cl<sup>-</sup> 3 mg/L  
 3. NO<sub>2</sub><sup>-</sup> 5 mg/L  
 4. Br<sup>-</sup> 10 mg/L  
 5. NO<sub>3</sub><sup>-</sup> 10 mg/L  
 6. HCO<sub>3</sub><sup>-</sup> 300 mg/L  
 7. HPO<sub>4</sub><sup>2-</sup> 15 mg/L  
 8. SO<sub>4</sub><sup>2-</sup> 15 mg/L

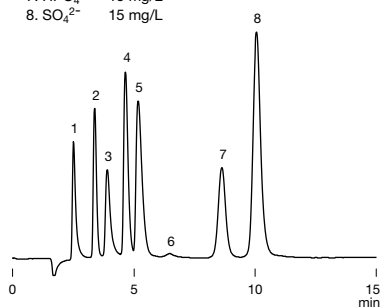

**Column** : Shodex IC SI-90 4E  
**Eluent** : 1.8 mM Na<sub>2</sub>CO<sub>3</sub> + 1.7 mM NaHCO<sub>3</sub> aq.  
**Flow rate** : 1.5 mL/min  
**Detector** : Suppressed conductivity  
**Column temp.** : Room temp. (25 °C)

### Anion analysis using SI-50 4E (suppressor method)

SI-50 4E is a high performance type of SI-90 4E. Acetic acid, formic acid, and methacrylic acid elute between F<sup>-</sup> and Cl<sup>-</sup>. The carbonate system peak appears between NO<sub>2</sub><sup>-</sup> and Br<sup>-</sup> peaks.

Sample : 20 µL  
 1. F<sup>-</sup> 2 mg/L  
 2. Acetic acid 10 mg/L  
 3. Formic acid 2 mg/L  
 4. Methacrylic acid 10 mg/L  
 5. Cl<sup>-</sup> 3 mg/L  
 6. NO<sub>2</sub><sup>-</sup> 5 mg/L  
 7. Br<sup>-</sup> 10 mg/L  
 8. NO<sub>3</sub><sup>-</sup> 10 mg/L  
 9. HPO<sub>4</sub><sup>2-</sup> 15 mg/L  
 10. SO<sub>4</sub><sup>2-</sup> 15 mg/L  
 11. Oxalic acid 15 mg/L

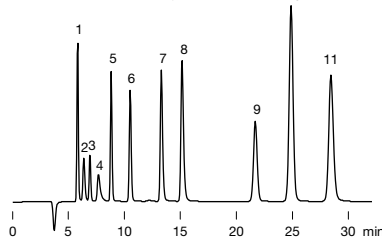

**Column** : Shodex IC SI-50 4E  
**Eluent** : 3.2 mM Na<sub>2</sub>CO<sub>3</sub> + 1.0 mM NaHCO<sub>3</sub> aq.  
**Flow rate** : 0.7 mL/min  
**Detector** : Suppressed conductivity  
**Column temp.** : 25 °C

### Oxyhalides and anions analysis using SI-52 4E (suppressor method)

SI-52 4E is a high resolution column offering 14,000 or higher theoretical plate number. It supports simultaneous analysis of oxyhalides and inorganic anions. It is recommended to set the column temperature at 45 °C.

Sample : 50 µL  
 1. F<sup>-</sup> 2 mg/L  
 2. ClO<sub>2</sub><sup>-</sup> 1 mg/L  
 3. BrO<sub>3</sub><sup>-</sup> 1 mg/L  
 4. Cl<sup>-</sup> 10 mg/L  
 5. NO<sub>2</sub><sup>-</sup> 5 mg/L  
 6. Br<sup>-</sup> 10 mg/L  
 7. ClO<sub>3</sub><sup>-</sup> 1 mg/L  
 8. Dichloroacetic acid 1 mg/L  
 9. NO<sub>3</sub><sup>-</sup> 30 mg/L  
 10. HPO<sub>4</sub><sup>2-</sup> 15 mg/L  
 11. SO<sub>4</sub><sup>2-</sup> 40 mg/L

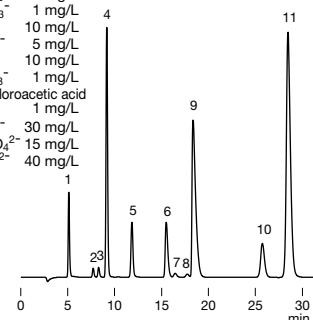

**Column** : Shodex IC SI-52 4E  
**Eluent** : 3.6 mM Na<sub>2</sub>CO<sub>3</sub> aq.  
**Flow rate** : 0.8 mL/min  
**Detector** : Suppressed conductivity  
**Column temp.** : 45 °C

### Rapid analysis of oxyhalides and anions using SI-35 4D (suppressor method)

Sample : 20 µL  
 1. F<sup>-</sup> 2 mg/L  
 2. ClO<sub>2</sub><sup>-</sup> 1 mg/L  
 3. BrO<sub>3</sub><sup>-</sup> 1 mg/L  
 4. Cl<sup>-</sup> 10 mg/L  
 5. NO<sub>2</sub><sup>-</sup> 5 mg/L  
 6. Br<sup>-</sup> 10 mg/L  
 7. ClO<sub>3</sub><sup>-</sup> 1 mg/L  
 8. NO<sub>3</sub><sup>-</sup> 30 mg/L  
 9. HPO<sub>4</sub><sup>2-</sup> 15 mg/L  
 10. SO<sub>4</sub><sup>2-</sup> 40 mg/L

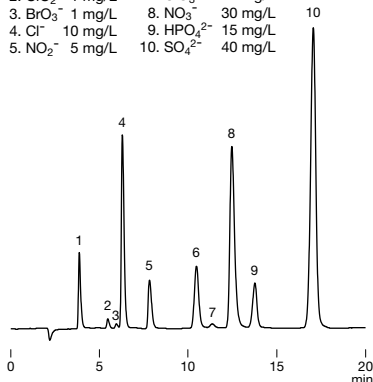

**Column** : Shodex IC SI-35 4D  
**Eluent** : 2.0 mM Na<sub>2</sub>CO<sub>3</sub> + 4.5 mM NaHCO<sub>3</sub> aq.  
**Flow rate** : 0.6 mL/min  
**Detector** : Suppressed conductivity  
**Column temp.** : 45 °C

### Anions and sulfate ion analysis using SI-36 4D (suppressor method)

Sample : 25 µL  
 1. F<sup>-</sup> 0.5 mg/L  
 2. Cl<sup>-</sup> 3 mg/L  
 3. NO<sub>2</sub><sup>-</sup> 5 mg/L  
 4. SO<sub>3</sub><sup>2-</sup> 5 mg/L  
 5. SO<sub>4</sub><sup>2-</sup> 10 mg/L  
 6. Br<sup>-</sup> 10 mg/L  
 7. NO<sub>3</sub><sup>-</sup> 10 mg/L  
 8. PO<sub>4</sub><sup>3-</sup> 15 mg/L

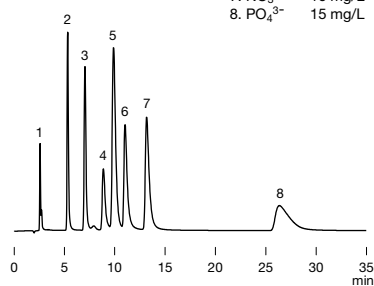

**Column** : Shodex IC SI-36 4D  
**Eluent** : 25 mM KOH aq.  
**Flow rate** : 0.7 mL/min  
**Detector** : Suppressed conductivity  
**Column temp.** : 30 °C

Eluent source : Dionex EGC 500 KOH

### Analysis of Oxyhalides in Artificial-Drinking Water According to EPA Method 300.1 (suppressor method)

Sample : 200 µL (simulated drinking water)  
 1. F<sup>-</sup> 1 mg/L  
 2. ClO<sub>2</sub><sup>-</sup> 5 µg/L  
 3. BrO<sub>3</sub><sup>-</sup> 5 µg/L  
 4. Cl<sup>-</sup> 50 mg/L  
 5. NO<sub>2</sub><sup>-</sup> 5 µg/L  
 6. ClO<sub>3</sub><sup>-</sup> 5 µg/L  
 7. Br<sup>-</sup> 5 µg/L  
 8. NO<sub>3</sub><sup>-</sup> 10 mg/L  
 9. CO<sub>3</sub><sup>2-</sup> 25 mg/L  
 10. SO<sub>4</sub><sup>2-</sup> 50 mg/L  
 11. PO<sub>4</sub><sup>3-</sup> 0.2 mg/L

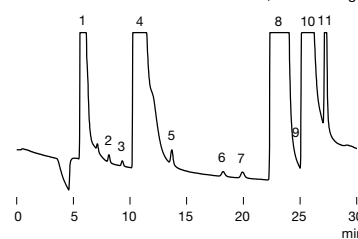

**Column** : Shodex IC SI-37 4D  
**Eluent** : (Gradient) KOH aq. 10 mM (0 to 21 min), 45 mM (21.01 to 40 min)  
**Flow rate** : 0.5 mL/min  
**Detector** : Suppressed conductivity  
**Column temp.** : 30 °C

Eluent source : Dionex EGC 500 KOH

## Cation analysis using YS-50 and YK-421

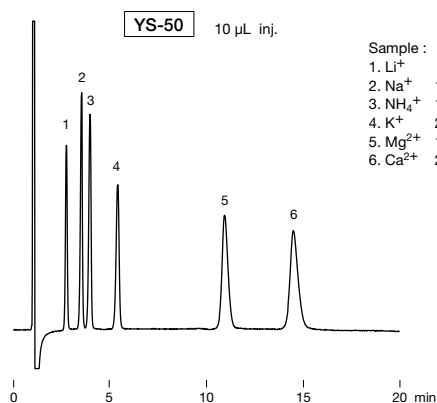

**Column** : Shodex IC YS-50  
**Eluent** : 4 mM Methanesulfonic acid aq.  
**Flow rate** : 1.0 mL/min  
**Detector** : Non-suppressed conductivity  
**Column temp.** : 40 °C

Sample :  
 1. Li<sup>+</sup> 2 mg/L  
 2. Na<sup>+</sup> 10 mg/L  
 3. NH<sub>4</sub><sup>+</sup> 10 mg/L  
 4. K<sup>+</sup> 20 mg/L  
 5. Mg<sup>2+</sup> 10 mg/L  
 6. Ca<sup>2+</sup> 20 mg/L

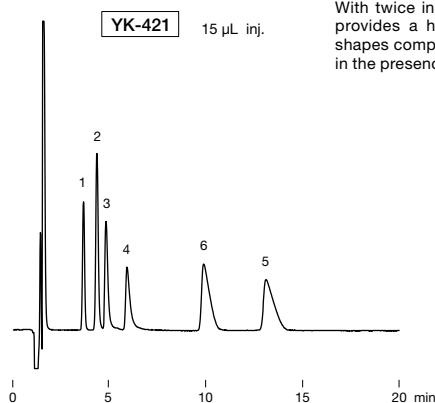

**Column** : Shodex IC YK-421  
**Eluent** : 5 mM Tartaric acid + 1 mM Dipicolinic acid + 24 mM Boric acid aq.  
**Flow rate** : 1.0 mL/min  
**Detector** : Non-suppressed conductivity  
**Column temp.** : 40 °C

With twice increased theoretical plate number, YS-50 provides a higher performance with improved peak shapes compared to YK-421. The quantitation of NH<sub>4</sub><sup>+</sup> in the presence of high Na<sup>+</sup> content is also improved.

TP	YS-50	YK-421
Mg <sup>2+</sup>	6,900	3,000
Ca <sup>2+</sup>	6,600	3,000

Resolution (Na <sup>+</sup> / NH <sub>4</sub> <sup>+</sup> )	YS-50	YK-421
	2.5	2.1

## Effects of added crown ether in the eluent

The elution of cations (particularly K<sup>+</sup>) can be well controlled by modifying the eluent concentration, as it provides different complex formation rate.

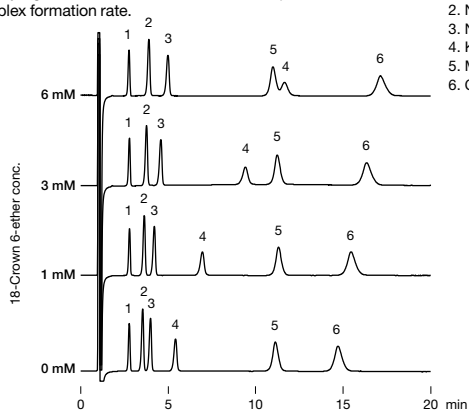

**Column** : Shodex IC YS-50  
**Eluent** : 4 mM Methanesulfonic acid + 18-Crown 6-ether aq.  
**Flow rate** : 1.0 mL/min  
**Detector** : Non-suppressed conductivity  
**Column temp.** : 40 °C

Sample : 10 µL  
 1. Li<sup>+</sup> 2 mg/L  
 2. Na<sup>+</sup> 10 mg/L  
 3. NH<sub>4</sub><sup>+</sup> 10 mg/L  
 4. K<sup>+</sup> 20 mg/L  
 5. Mg<sup>2+</sup> 10 mg/L  
 6. Ca<sup>2+</sup> 20 mg/L

## Simultaneous analysis of cations and ethylenediamine

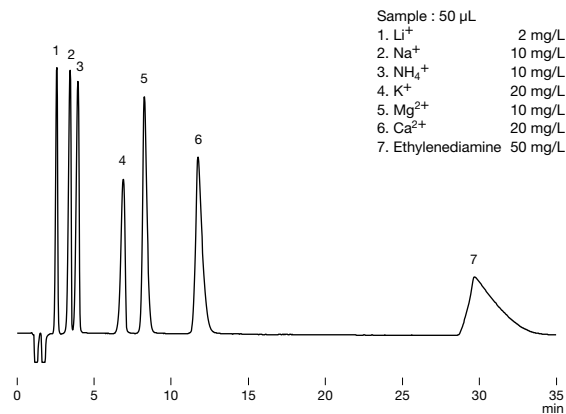

**Column** : Shodex IC YS-50  
**Eluent** : 4 mM Nitric acid + 1.5 mM 18-Crown 6-ether aq. /CH<sub>3</sub>CN = 90/10  
**Flow rate** : 1.0 mL/min  
**Detector** : Non-suppressed conductivity  
**Column temp.** : 40 °C

Sample : 50 µL  
 1. Li<sup>+</sup> 2 mg/L  
 2. Na<sup>+</sup> 10 mg/L  
 3. NH<sub>4</sub><sup>+</sup> 10 mg/L  
 4. K<sup>+</sup> 20 mg/L  
 5. Mg<sup>2+</sup> 10 mg/L  
 6. Ca<sup>2+</sup> 20 mg/L  
 7. Ethylenediamine 50 mg/L

## Amino alcohols

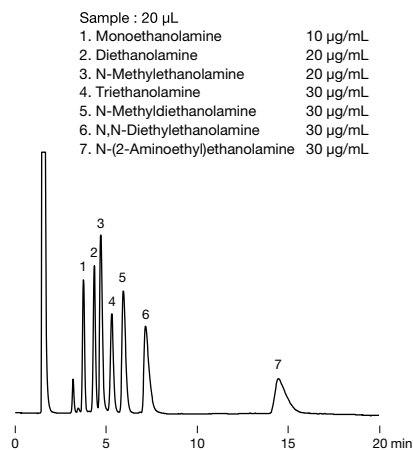

**Column** : Shodex IC YK-421  
**Eluent** : 4 mM Nitric acid aq.  
**Flow rate** : 1.0 mL/min  
**Detector** : Non-suppressed conductivity  
**Column temp.** : 40 °C

Sample : 20 µL  
 1. Monoethanolamine 10 µg/mL  
 2. Diethanolamine 20 µg/mL  
 3. N-Methylethanolamine 20 µg/mL  
 4. Triethanolamine 30 µg/mL  
 5. N-Methyldiethanolamine 30 µg/mL  
 6. N,N-Diethylethanolamine 30 µg/mL  
 7. N-(2-Aminoethyl)ethanolamine 30 µg/mL

## Alkylamines

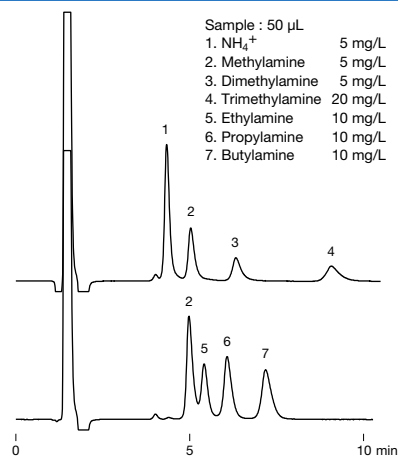

**Column** : Shodex IC YK-421  
**Eluent** : 4 mM H<sub>3</sub>PO<sub>4</sub> aq./CH<sub>3</sub>CN = 90/10  
**Flow rate** : 1.0 mL/min  
**Detector** : Non-suppressed conductivity  
**Column temp.** : 25 °C

Sample : 50 µL  
 1. NH<sub>4</sub><sup>+</sup> 5 mg/L  
 2. Methylamine 5 mg/L  
 3. Dimethylamine 5 mg/L  
 4. Trimethylamine 20 mg/L  
 5. Ethylamine 10 mg/L  
 6. Propylamine 10 mg/L  
 7. Butylamine 10 mg/L

# Aqueous SEC (GFC) Columns: Silica-based

## Features

<b>KW-800</b>	<ul style="list-style-type: none"> <li>• Silica-based packed columns for aqueous SEC (GFC) analysis</li> <li>• Suitable for the analysis of proteins and enzymes</li> <li>• Fulfills USP-NF L20, L33, and L59 requirements</li> </ul>
<b>KW400</b>	<ul style="list-style-type: none"> <li>• Reduced packing material particle size enhances column performance</li> <li>• Three to four-fold higher sensitivity than KW-800 series</li> <li>• KW405-4F is applicable analyzing samples with molecular weight above 1,000,000</li> <li>• Fulfills USP-NF L20, L33, and L59 requirements</li> </ul>
<b>LW-803</b>	<ul style="list-style-type: none"> <li>• Pore size specifically controlled for analyzing proteins with a molecular weight of several hundred of thousand</li> <li>• High performance analysis of antibody drugs and various proteins</li> <li>• High lot-to-lot reproducibility</li> <li>• Fulfills USP-NF L20, L33, and L59 requirements</li> </ul>
<b>LW-403 4D</b>	<ul style="list-style-type: none"> <li>• Rapid analysis column of LW-803</li> <li>• Achieves approximately halved analysis time compared with standard column</li> <li>• Fulfills USP-NF L20, L33, and L59 requirements</li> </ul>

## • Standard columns

Product Code	Product Name	* Plate Number (TP/column)	Particle Size (µm)	Pore Size (Å)	Column Size (mm) I.D. x Length	Shipping Solvent
F6989000	<b>PROTEIN KW-802.5</b>	≥ 21,000	5	400	<b>8.0 x 300</b>	H <sub>2</sub> O
F6989103	<b>PROTEIN KW-803</b>	≥ 21,000	5	1,000	<b>8.0 x 300</b>	H <sub>2</sub> O
F6989104	<b>PROTEIN KW-804</b>	≥ 16,000	7	1,500	<b>8.0 x 300</b>	H <sub>2</sub> O
F6700131	<b>PROTEIN KW-G 6B</b>	(guard column)	7	—	<b>6.0 x 50</b>	H <sub>2</sub> O

\* Measured with ethylene glycol

Base Material: Silica  
Usable pH Range: pH3.0 - 7.5

## • High performance semi-micro columns

\* KW400 series is recommended to be used with semi-micro type devices.

Product Code	Product Name	* Plate Number (TP/column)	Particle Size (µm)	Pore Size (Å)	Column Size (mm) I.D. x Length	Shipping Solvent
F6989201	<b>KW402.5-4F</b>	≥ 35,000	3	400	<b>4.6 x 300</b>	H <sub>2</sub> O
F6989202	<b>KW403-4F</b>	≥ 35,000	3	800	<b>4.6 x 300</b>	H <sub>2</sub> O
F6989203	<b>KW404-4F</b>	≥ 25,000	5	1,500	<b>4.6 x 300</b>	H <sub>2</sub> O
F6989204	<b>KW405-4F</b>	≥ 25,000	5	2,000	<b>4.6 x 300</b>	H <sub>2</sub> O
F6700132	<b>KW400G-4A</b>	(guard column)	5	—	<b>4.6 x 10</b>	H <sub>2</sub> O

\* Measured with uridine

Base Material: Silica  
Usable pH Range: pH3.0 - 7.5

## For antibody drugs analysis

## ● Standard columns

Product Code	Product Name	* Plate Number (TP/column)	Particle Size (µm)	Pore Size (Å)	Column Size (mm) I.D. x Length	Shipping Solvent
F6989303	<b>PROTEIN LW-803</b>	≥ 12,000	3	1,000	<b>8.0 x 300</b>	H <sub>2</sub> O
F6700133	<b>PROTEIN LW-G 6B</b>	(guard column)	3	—	<b>6.0 x 50</b>	H <sub>2</sub> O

\* Measured with bovine serum albumin

Base Material: Silica  
Usable pH Range: pH3.0 - 7.5

## ● Semi-micro columns

\* LW-403 4D is recommended to be used with semi-micro type devices.

Product Code	Product Name	* Plate Number (TP/column)	Particle Size (µm)	Pore Size (Å)	Column Size (mm) I.D. x Length	Shipping Solvent
F6989403	<b>PROTEIN LW-403 4D</b>	≥ 11,000	1.9	1,000	<b>4.6 x 150</b>	H <sub>2</sub> O
F6700134	<b>PROTEIN LS-G 4J</b>	(guard column)	1.9	—	<b>4.6 x 20</b>	H <sub>2</sub> O

\* Measured with bovine serum albumin

Base Material: Silica  
Usable pH Range: pH3.0 - 7.5

## Usable solvents

Product Name	Solvent			
	Acetonitrile	Methanol	Ethanol	2-Propanol (IPA)
<b>KW-802.5, KW-803, KW-804</b>	✓	✓	✓	✓
<b>KW402.5-4F</b>	✓	✓	✓	△
<b>KW403-4F</b>	✓	✓	✓	×
<b>KW404-4F, KW405-4F</b>	✓	✓	✓	✓
<b>LW-803</b>	✓	✓	✓	✓
<b>LW-403 4D</b>	✓	✓	✓	×

✓: Solvent replacement possible    △: Solvent replacement possible up to 50 %    ×: Solvent replacement not possible

## Target molecular weight range and exclusion limit

## ● Measured with protein (eluent: phosphate buffer)

Product Name	Target Molecular Weight Range	Exclusion Limit
<b>KW-802.5</b>	5,000 - 100,000	150,000
<b>KW-803</b>	10,000 - 700,000	* (1,000,000)
<b>KW-804</b>	30,000 - * (4,000,000)	* (4,000,000)
<b>KW402.5-4F</b>	5,000 - 70,000	150,000
<b>KW403-4F</b>	10,000 - 500,000	600,000
<b>KW404-4F</b>	30,000 - * (4,000,000)	* (4,000,000)
<b>KW405-4F</b>	200,000 - * (20,000,000)	* (20,000,000)
<b>LW-803, LW-403 4D</b>	10,000 - 700,000	* (1,000,000)

Please use the above table for reference purposes only when selecting columns.

\* ( ) Estimated value

## ● Measured with pullulan (eluent: ultrapure water)

Product Name	Target Molecular Weight Range	Exclusion Limit
<b>KW-802.5</b>	2,000 - 50,000	60,000
<b>KW-803</b>	5,000 - 100,000	170,000
<b>KW-804</b>	20,000 - 300,000	500,000
<b>KW402.5-4F</b>	2,000 - 40,000	60,000
<b>KW403-4F</b>	3,000 - 50,000	80,000
<b>KW404-4F</b>	20,000 - 300,000	400,000
<b>KW405-4F</b>	100,000 - 700,000	1,300,000

Please use the above table for reference purposes only when selecting columns.

**Calibration curves for KW-800 series using protein**

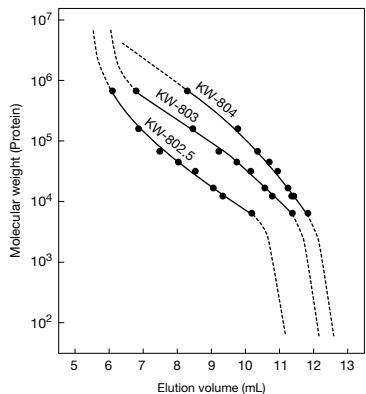

**Column** : Shodex PROTEIN KW-800 series  
**Eluent** : 50 mM Sodium phosphate buffer (pH7.0) + 0.3 M NaCl  
**Flow rate** : 1.0 mL/min  
**Detector** : UV (280 nm)  
**Column temp.** : 30 °C

**Calibration curves for KW400 series using protein**

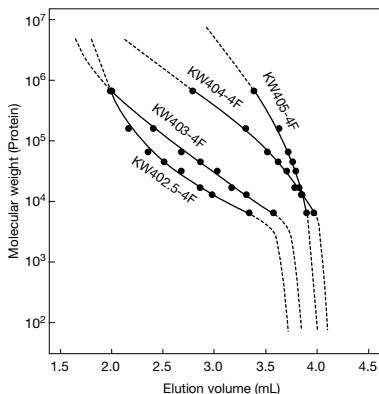

**Column** : Shodex KW400-4F series  
**Eluent** : 50 mM Sodium phosphate buffer (pH7.0) + 0.3 M NaCl  
**Flow rate** : 0.33 mL/min  
**Detector** : UV (280 nm) (small cell volume)  
**Column temp.** : 30 °C

**Calibration curve for LW-803 using protein**

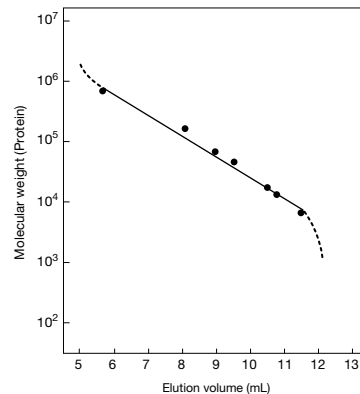

**Column** : Shodex PROTEIN LW-803  
**Eluent** : 50 mM Sodium phosphate buffer (pH7.0) + 0.3 M NaCl  
**Flow rate** : 1.0 mL/min  
**Detector** : UV (280 nm)  
**Column temp.** : Room temp.

**Calibration curve for LW-403 4D using protein**

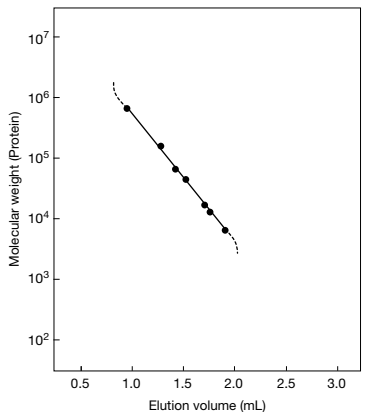

**Column** : Shodex PROTEIN LW-403 4D  
**Eluent** : 50 mM Sodium phosphate buffer (pH7.0) + 0.3 M NaCl  
**Flow rate** : 0.35 mL/min  
**Detector** : UV (280 nm) (small cell volume)  
**Column temp.** : 30 °C

**Analysis of impurities (high molecular weight proteins) in insulin glargine according to USP-NF method**

**Sample** : 100 µL  
**System suitability solution** (prepared following USP-NF method)  
 1. High molecular weight proteins  
 2. Insulin glargine

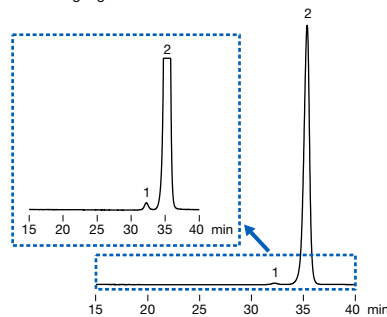

**Column** : Shodex PROTEIN KW-802.5 x 2  
**Eluent** : CH<sub>3</sub>COOH/CH<sub>3</sub>CN/H<sub>2</sub>O=20/30/50 (pH to 3.0 adjusted with 25 % NH<sub>3</sub> aq.)  
**Flow rate** : 0.5 mL/min  
**Detector** : UV (276 nm)  
**Column temp.** : Ambient

**Lipoproteins in serum**

**Sample** : 40 µL  
 Whole lipoproteins from serum of a healthy person 1.0 mg/mL  
 1. VLDL 2. LDL 3. HDL  
 (Sample preparation method)  
 1. Use potassium bromide to adjust the specific gravity of serum from a healthy person to 1.210 g/mL. Ultracentrifuge for 24 hours.  
 2. Dialyze the supernatant and then substitute the solvent with PBS\*.  
 3. Measure protein concentration by Lowry method and dilute the sample with PBS\* to 1.0 mg/mL.

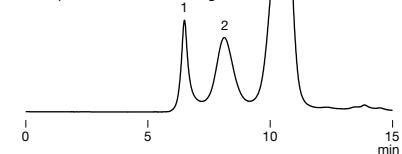

**Column** : Shodex PROTEIN KW-G + KW-804  
**Eluent** : 10-fold diluted x 10 PBS\* with H<sub>2</sub>O  
**Flow rate** : 1.0 mL/min  
**Detector** : UV (280 nm)  
**Column temp.** : 30 °C  
 x10 PBS\* : 80 g NaCl + 29 g Na<sub>2</sub>HPO<sub>4</sub> · 12H<sub>2</sub>O + 2 g KCl + 2 g KH<sub>2</sub>PO<sub>4</sub> in 1000 mL of H<sub>2</sub>O  
 Data provided by Prof. Ohkawa Ryunosuke, Graduate School of Health Care Sciences, Analytical Laboratory Chemistry, Tokyo Medical and Dental University

**Proteins in human blood serum**

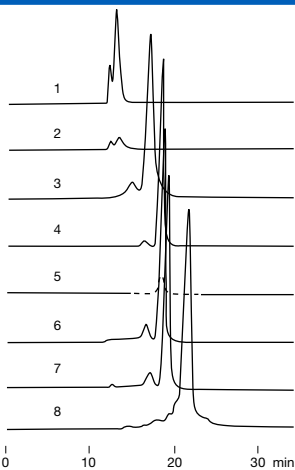

**Sample** : 0.1 % each  
 1. Fibrinogen 50 µL  
 2. α<sub>2</sub>-Macroglobulin 50 µL  
 3. IgG 50 µL  
 4. Transferrin 50 µL  
 5. Plasminogen 50 µL  
 6. Albumin 100 µL  
 7. Antitrypsin 100 µL  
 8. Hemoglobin 100 µL

**Column** : Shodex PROTEIN KW-803  
**Eluent** : 50 mM Sodium phosphate buffer (pH7.0) + 0.3 M NaCl  
**Flow rate** : 1.0 mL/min  
**Detector** : UV (280 nm)  
**Column temp.** : Room temp.

**Comparing three GFC columns for the separation of common proteins**

**Sample** :  
 1. Thyroglobulin (bovine)  
 2. γ-Globulin (bovine)  
 3. Ovalbumin (chicken)  
 4. Myoglobin (horse)  
 5. Cyanocobalamin

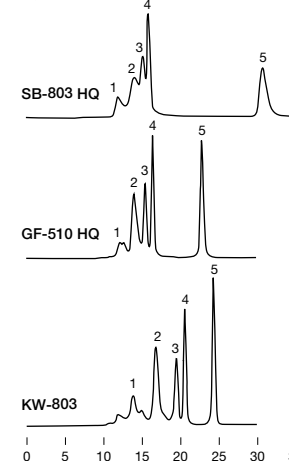

Separation performances of three aqueous SEC columns (SB-803 HQ, GF-510 HQ, and KW-803) were compared. KW-803, silica-based column, showed the best separation performance for the analysis of protein standards.

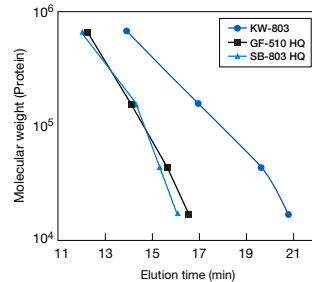

**Column** : Shodex OHpak SB-803 HQ  
 Shodex Asahipak GF-510 HQ  
 Shodex PROTEIN KW-803  
**Eluent** : 0.2 M Phosphate buffer (pH6.9)  
**Flow rate** : 0.5 mL/min  
**Detector** : UV (280 nm)  
**Column temp.** : 30 °C

### Comparison of LW-803, conventional column, and other manufacturer's column

PROTEIN LW-803 is suitable for analyzing a few-hundred-thousand molecular weight size proteins. When comparing LW-803 to our conventional columns and other manufacturer's columns, LW-803 provides a better separation around 160,000 molecular weight range that is about the size of Globulin. This improved separation efficiency is advantageous for the separation of monomer and dimer of IgG which is a mainstream of antibody drug.

Sample : 5  $\mu$ L

1. Thyroglobulin (MW : 670,000) 7 mg/mL
2.  $\gamma$ -Globulin (MW : 160,000) 6 mg/mL
3. Ovalbumin (MW : 44,300) 4.8 mg/mL
4. Ribonuclease A (MW : 13,700) 7 mg/mL
5. Uridine (MW : 244) 0.1 mg/mL

**LW-803**

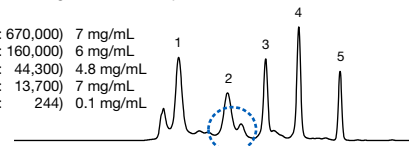

**KW-803 (conventional type)**

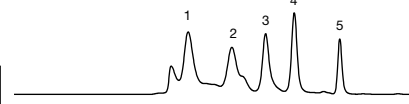

**Company A**

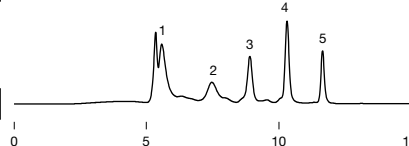

Sample : 5  $\mu$ L

- IgG from human serum 10 mg/mL
1. Aggregates
  2. Dimer
  3. Monomer

**LW-803**

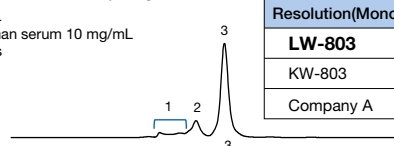

**KW-803 (conventional type)**

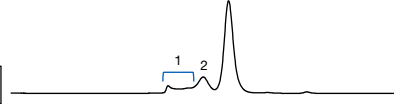

**Company A**

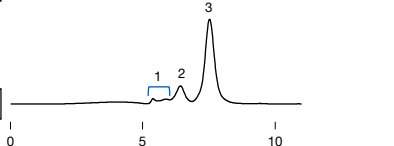

Resolution(Monomer/Dimer)	
<b>LW-803</b>	<b>2.2</b>
KW-803	1.6
Company A	1.9

**Column** : Shodex PROTEIN LW-803, Shodex PROTEIN KW-803, Silica-based SEC column from other manufacturer  
**Eluent** : 50 mM Sodium phosphate buffer (pH7.0) + 0.3 M NaCl  
**Flow rate** : 1.0 mL/min  
**Detector** : UV (280 nm)  
**Column temp.** : Room temp.

### Monitoring papain digestion of humanized monoclonal IgG

Papain digestion of humanized monoclonal IgG was monitored using PROTEIN LW-803, an aqueous SEC (GFC) column. During the papain digestion of IgG, Fc and Fab fragments from the IgG and their decomposition intermediates are expected to be observed. LW-803 separates IgG and decomposed fragments and intermediates well from each other, thus it is suitable for the monitoring of papain digestion of IgG.

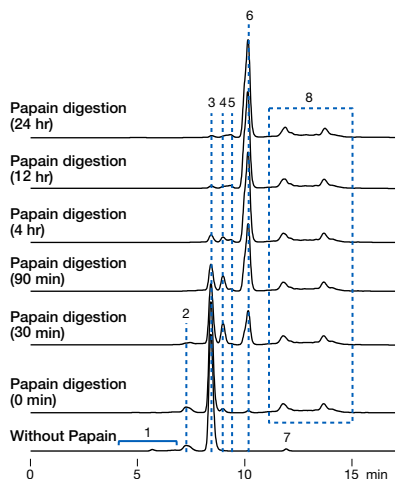

Sample : 10  $\mu$ L

- Humanized monoclonal IgG
1. Aggregates of IgG
  2. Dimer of IgG
  3. Monomer of IgG
  - 4 - 6. Fragments of IgG from papain digestion
  7. Citric acid
  8. Papain

(Procedures for digestion monitoring)

- (1) Dissolve 3 mg of humanized monoclonal IgG in 500  $\mu$ L of the eluent. (6 mg/mL conc.)
- (2) Dissolve 1 mg of papain in 500  $\mu$ L of the eluent. (1 mg/mL conc.)
- (3) Filter (1) and (2) using 0.2- $\mu$ m membrane filters
- (4) Mix two solutions in 1:1 ratio.
- (5) Keep the mixture at 25  $^{\circ}$ C.
- (6) Take samples at set timings and analyze them by HPLC.

**Column** : Shodex PROTEIN LW-803  
**Eluent** : 0.1 M Sodium phosphate buffer (pH7.0) + 0.3 M NaCl  
**Flow rate** : 1.0 mL/min  
**Detector** : UV (280 nm)  
**Column temp.** : 25  $^{\circ}$ C

### Antibody-drug Conjugate (ADC)

Sample : 20  $\mu$ L  
 Antibody-drug conjugate formulation 5 mg/mL (in H<sub>2</sub>O)

1. Dimer
2. Monomer

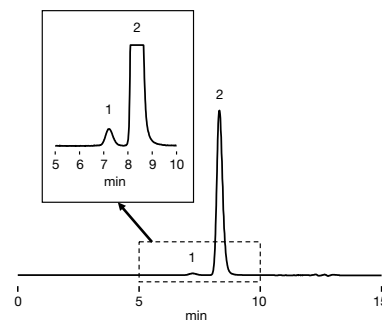

**Column** : Shodex PROTEIN LW-803  
**Eluent** : 50 mM Sodium phosphate buffer (pH7.0) + 0.3 M NaCl  
**Flow rate** : 1.0 mL/min  
**Detector** : UV (280 nm)  
**Column temp.** : 25  $^{\circ}$ C

### Comparison of KW402.5-4F and KW-802.5

KW400 series is a high performance type semi-micro columns. It offers approximately 1.5 times larger theoretical plate number and 3 to 4 times higher detection sensitivity (peak height) than KW-800 series columns do.

Sample : 10  $\mu$ L

1. Blue dextran 2000 0.2 mg/mL
2.  $\gamma$ -Globulin 0.8 mg/mL
3. Ovalbumin 0.8 mg/mL
4. Myoglobin 0.56 mg/mL
5. Uridine 0.04 mg/mL

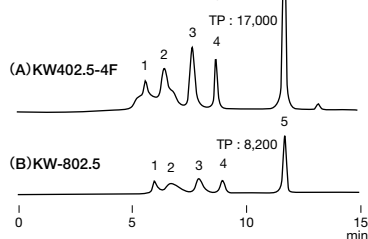

**Column** : (A) Shodex KW402.5-4F  
 (B) Shodex PROTEIN KW-802.5  
**Eluent** : 50 mM Sodium phosphate buffer (pH7.0) + 0.3 M NaCl  
**Flow rate** : (A) 0.33 mL/min, (B) 1.0 mL/min  
**Detector** : UV (280 nm) (small cell volume)  
**Column temp.** : 25  $^{\circ}$ C

### Yogurt whey

Sample : Whey, 5  $\mu$ L

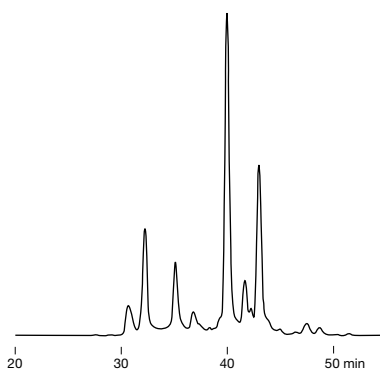

**Column** : Shodex KW403-4F + KW402.5-4F  
**Eluent** : 50 mM Sodium phosphate buffer (pH7.0) + 0.3 M NaCl  
**Flow rate** : 0.20 mL/min  
**Detector** : UV (280 nm) (small cell volume)  
**Column temp.** : 30  $^{\circ}$ C

### Lectins

Sample : 5  $\mu$ L

1. Lectin from soybean 0.6 mg/mL
2. Lectin from arachis hypogaea 1.1 mg/mL
3. Lectin from canavalia ensiformis (Con A) 0.9 mg/mL
4. Lectin from lens culinaris (LCA) 0.7 mg/mL
5. Lectin from triticum vulgaris (WGA) 0.8 mg/mL

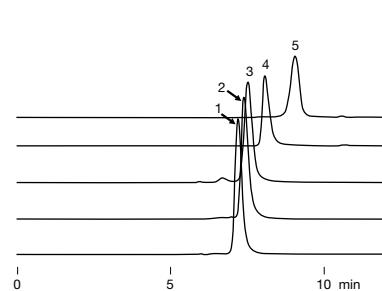

**Column** : Shodex KW402.5-4F  
**Eluent** : 50 mM Sodium phosphate buffer (pH7.0) + 0.3 M NaCl  
**Flow rate** : 0.33 mL/min  
**Detector** : UV (220 nm) (small cell volume)  
**Column temp.** : 30  $^{\circ}$ C

# Aqueous SEC (GFC) Columns: Polymer-based

## Features

### SB-800 HQ

- Polymer-based packed columns for aqueous SEC (GFC) analysis
- Supports a wide range of molecular weight sample analysis
- The eluent can be replaced with DMF (except SB-802 HQ and SB-807 HQ), enabling the analysis of polar polymers
- Method using SB-804 HQ or SB-805 HQ for gelatin's mean molecular weight determination is comparable with PAGI method (Ver. 10, Japan)
- Fulfills USP-NF L38 and L39 requirements
- SB-802 HQ fulfills USP-NF L25 requirements
- SB-802.5 HQ fulfills USP-NF L25 and L89 requirements
- SB-803 HQ fulfills USP-NF L37 requirements

### SB-807 HQ

- Column for the analysis of water-soluble ultra high molecular weight polymers
- Large particle-size gel prevents shear degradation of polymers
- Fulfills USP-NF L38 and L39 requirements

### LB-800

- Polymer-based packed columns for aqueous SEC (GFC) analysis
- Low column bleeding allows its use with light scattering detectors
- The eluent can be replaced with DMF enabling the analysis of polar polymers
- Fulfills USP-NF L38 and L39 requirements
- LB-802.5 fulfills USP-NF L25 and L89 requirements
- LB-803 fulfills USP-NF L37 requirements

## Standard columns

Product Code	Product Name	Plate Number (TP/column)	Particle Size (µm)	Pore Size (Å)	Column Size (mm) I.D. x Length	Shipping Solvent
F6429100	<b>OHpak SB-802 HQ</b>	≥ 12,000	8	100	<b>8.0 x 300</b>	0.02 % NaN <sub>3</sub> aq.
F6429101	<b>OHpak SB-802.5 HQ</b>	≥ 16,000	6	200	<b>8.0 x 300</b>	0.02 % NaN <sub>3</sub> aq.
F6429102	<b>OHpak SB-803 HQ</b>	≥ 16,000	6	800	<b>8.0 x 300</b>	0.02 % NaN <sub>3</sub> aq.
F6429103	<b>OHpak SB-804 HQ</b>	≥ 16,000	10	2,000	<b>8.0 x 300</b>	0.02 % NaN <sub>3</sub> aq.
F6429104	<b>OHpak SB-805 HQ</b>	≥ 12,000	13	7,000	<b>8.0 x 300</b>	0.02 % NaN <sub>3</sub> aq.
F6429105	<b>OHpak SB-806 HQ</b>	≥ 12,000	13	15,000	<b>8.0 x 300</b>	0.02 % NaN <sub>3</sub> aq.
F6429106	<b>OHpak SB-806M HQ</b>	≥ 12,000	13	15,000	<b>8.0 x 300</b>	0.02 % NaN <sub>3</sub> aq.
F6709430	<b>OHpak SB-G 6B</b>	(guard column)	10	—	<b>6.0 x 50</b>	0.02 % NaN <sub>3</sub> aq.

SB-806M HQ is a mixed-gel column capable of analyzing samples over a wide range of molecular weight distribution.

Base Material: Polyhydroxymethacrylate  
Usable pH Range: pH3 - 10

## Aqueous high molecular weight analysis column

### Standard columns

Product Code	Product Name	Plate Number (TP/column)	Particle Size (µm)	Pore Size (Å)	Column Size (mm) I.D. x Length	Shipping Solvent
F6429108	<b>OHpak SB-807 HQ</b>	≥ 1,500	35	30,000	<b>8.0 x 300</b>	H <sub>2</sub> O
F6709431	<b>OHpak SB-807G</b>	(guard column)	35	—	<b>8.0 x 50</b>	H <sub>2</sub> O

Base Material: Polyhydroxymethacrylate  
Usable pH Range: pH3 - 10

### Preparative columns [Preparative columns are made to order]

Product Code	Product Name	Plate Number (TP/column)	Particle Size (µm)	Column Size (mm) I.D. x Length	Shipping Solvent	Standard Column
F6516011	<b>OHpak SB-2002</b>	≥ 9,000	15	<b>20.0 x 300</b>	0.02 % NaN <sub>3</sub> aq.	SB-802 HQ
F6516012	<b>OHpak SB-2002.5</b>	≥ 12,000	10	<b>20.0 x 300</b>	0.02 % NaN <sub>3</sub> aq.	SB-802.5 HQ
F6516013	<b>OHpak SB-2003</b>	≥ 12,000	10	<b>20.0 x 300</b>	0.02 % NaN <sub>3</sub> aq.	SB-803 HQ
F6516014	<b>OHpak SB-2004</b>	≥ 12,000	18	<b>20.0 x 300</b>	0.02 % NaN <sub>3</sub> aq.	SB-804 HQ
F6516015	<b>OHpak SB-2005</b>	≥ 12,000	20	<b>20.0 x 300</b>	0.02 % NaN <sub>3</sub> aq.	SB-805 HQ
F6516016	<b>OHpak SB-2006</b>	≥ 12,000	20	<b>20.0 x 300</b>	0.02 % NaN <sub>3</sub> aq.	SB-806 HQ
F6516017	<b>OHpak SB-2006M</b>	≥ 12,000	20	<b>20.0 x 300</b>	0.02 % NaN <sub>3</sub> aq.	SB-806M HQ
F6709555	<b>OHpak SB-G 8B</b>	(guard column)	18	<b>8.0 x 50</b>	0.02 % NaN <sub>3</sub> aq.	(guard column)

Base Material: Polyhydroxymethacrylate



## GFC columns to be used with light scattering detector

## ● Standard columns

Product Code	Product Name	Plate Number (TP/column)	Particle Size (µm)	Pore Size (Å)	Column Size (mm) I.D. x Length	Shipping Solvent
F6429206	<b>OHpak LB-802.5</b>	≥ 16,000	6	200	<b>8.0 x 300</b>	H <sub>2</sub> O
F6429201	<b>OHpak LB-803</b>	≥ 16,000	6	800	<b>8.0 x 300</b>	H <sub>2</sub> O
F6429204	<b>OHpak LB-804</b>	≥ 16,000	10	2,000	<b>8.0 x 300</b>	H <sub>2</sub> O
F6429203	<b>OHpak LB-805</b>	≥ 12,000	13	7,000	<b>8.0 x 300</b>	H <sub>2</sub> O
F6429205	<b>OHpak LB-806</b>	≥ 12,000	13	15,000	<b>8.0 x 300</b>	H <sub>2</sub> O
F6429202	<b>OHpak LB-806M</b>	≥ 12,000	13	15,000	<b>8.0 x 300</b>	H <sub>2</sub> O
F6709434	<b>OHpak LB-G 6B</b>	(guard column)	13	—	<b>6.0 x 50</b>	H <sub>2</sub> O

LB-806M is a mixed-gel column capable of analyzing samples over a wide range of molecular weight distribution.

Base Material: Polyhydroxymethacrylate  
Usable pH Range: pH3 - 10

## Usable solvents

Product Name	Maximum Usable Concentration (%)			
	Methanol	Acetonitrile	N,N-Dimethylformamide (DMF)	*Dimethyl sulfoxide (DMSO)
<b>SB-802 HQ</b>	0	0	0	0
<b>SB-802.5 HQ, SB-803 HQ</b>	100	75	100	100
<b>SB-804 HQ - SB-806M HQ</b>	75	75	100	100
<b>SB-G 6B</b>	75	75	100	100
<b>SB-807 HQ, SB-807G</b>	30	30	0	0
<b>LB-802.5 - LB-806M, LB-G 6B</b>	100	100	100	—

(Note)

The maximum solvent tolerance of SB-2000 series, preparative columns of SB-800 HQ series, is 50 % methanol, acetonitrile, or DMF. (SB-2002 is not tolerant to organic solvents)

\*Use at 50 - 70 °C

## Target molecular weight range and exclusion limit

## ● Measured with pullulan (eluent: ultrapure water)

Product Name	Target Molecular Weight Range	Exclusion Limit
<b>SB-802 HQ</b>	200 - 1,000	1,000
<b>SB-802.5 HQ</b>	500 - 10,000	10,000
<b>SB-803 HQ</b>	1,000 - 100,000	100,000
<b>SB-804 HQ</b>	5,000 - 400,000	1,000,000
<b>SB-805 HQ</b>	100,000 - 1,000,000	* (4,000,000)
<b>SB-806 HQ</b>	100,000 - * (20,000,000)	* (20,000,000)
<b>SB-806M HQ</b>	500 - * (20,000,000)	* (20,000,000)
<b>SB-807 HQ</b>	500,000 - * (500,000,000)	* (500,000,000)
<b>LB-802.5</b>	500 - 10,000	10,000
<b>LB-803</b>	1,000 - 100,000	100,000
<b>LB-804</b>	5,000 - 400,000	1,000,000
<b>LB-805</b>	100,000 - 1,000,000	* (4,000,000)
<b>LB-806</b>	100,000 - * (20,000,000)	* (20,000,000)
<b>LB-806M</b>	500 - * (20,000,000)	* (20,000,000)

Please use the above table for reference purposes only when selecting columns.

\* ( ) Estimated value

## ● Measured with \*PEG/PEO (eluent: DMF)

Product Name	Target Molecular Weight Range
<b>SB-802.5 HQ</b>	100 - 2,000
<b>SB-803 HQ</b>	200 - 40,000
<b>SB-804 HQ</b>	500 - 300,000
<b>SB-805 HQ</b>	50,000 - 700,000
<b>SB-806 HQ</b>	70,000 - ** (20,000,000)
<b>SB-806M HQ</b>	200 - ** (20,000,000)
<b>LB-802.5</b>	100 - 5,000
<b>LB-803</b>	500 - 50,000
<b>LB-804</b>	500 - 300,000
<b>LB-805</b>	50,000 - 700,000
<b>LB-806</b>	70,000 - ** (20,000,000)
<b>LB-806M</b>	200 - ** (20,000,000)

Please use the above table for reference purposes only when selecting columns.

\*PEG: Polyethylene glycol  
\*PEO: Polyethylene oxide  
\*\* ( ) Estimated value

**Calibration curves for SB-800 HQ series using pullulan (eluent: H<sub>2</sub>O)**

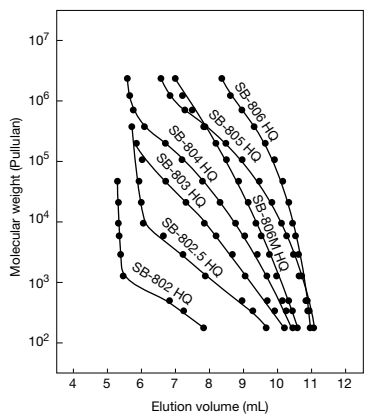

**Column** : Shodex OHpak SB-800 HQ series  
**Eluent** : H<sub>2</sub>O  
**Flow rate** : 1.0 mL/min  
**Detector** : RI  
**Column temp.** : 30 °C

**Calibration curves for SB-800 HQ series using PEG/PEO (eluent: DMF)**

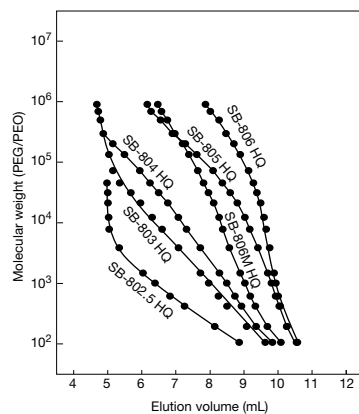

**Column** : Shodex OHpak SB-800 HQ series  
**Eluent** : DMF  
**Flow rate** : 1.0 mL/min  
**Detector** : RI  
**Column temp.** : 40 °C

**Carboxymethylcellulose**

Sample : Carboxymethylcellulose 0.1 % each, 50 µL

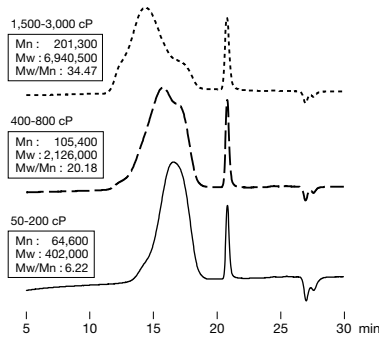

Molecular weight was determined from the calibration curve of pullulan.

**Column** : Shodex OHpak SB-806M HQ x 2  
**Eluent** : 0.1 M NaCl aq.  
**Flow rate** : 1.0 mL/min  
**Detector** : RI  
**Column temp.** : 40 °C

**Effects of sodium nitrate in eluent on polyallylamine analysis**

For the analysis of cationic polymers, such as polyallylamine, the polymer is observed to adsorb on the column or delayed in elution when low sodium nitrate eluent was used. These phenomena can be suppressed by increasing the concentration of sodium nitrate in the eluent. In the case of polyallylamine, a good shape chromatogram is obtained when sodium nitrate concentration is 0.1 M or higher.

Sample : Polyallylamine 0.2 %, 100 µL

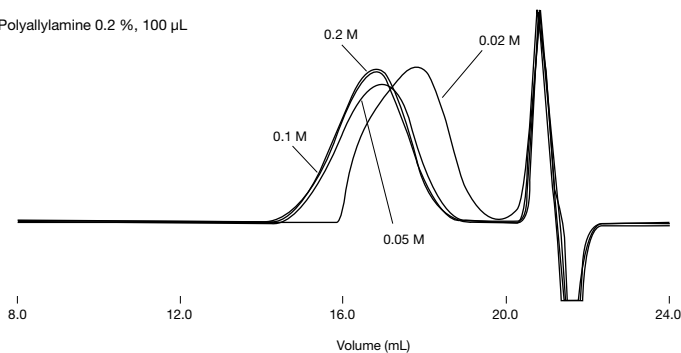

**Column** : Shodex OHpak SB-806M HQ x 2  
**Eluent** : 0.5 M CH<sub>3</sub>COOH + NaNO<sub>3</sub> aq.  
**Flow rate** : 1.0 mL/min  
**Detector** : RI  
**Column temp.** : 40 °C

**Gelatin**

Sample : 0.1 % each, 100 µL  
 Gelatin from bovine skin (Acid treatment, Gel strength : 225 g)  
 Gelatin from porcine skin (Alkali treatment, Gel strength : 90-100 g)

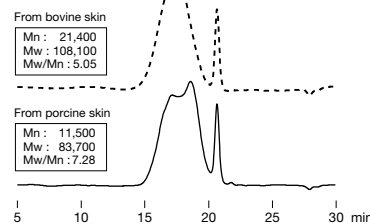

\*Molecular weight was determined from the calibration curve of pullulan.

**Column** : Shodex OHpak SB-806M HQ x 2  
**Eluent** : 0.1 M KH<sub>2</sub>PO<sub>4</sub> aq./ 0.1 M Na<sub>2</sub>HPO<sub>4</sub> aq. = 50/50  
**Flow rate** : 1.0 mL/min  
**Detector** : RI  
**Column temp.** : 40 °C

**Polyacrylamide**

Sample : Polyacrylamide, 100 µL

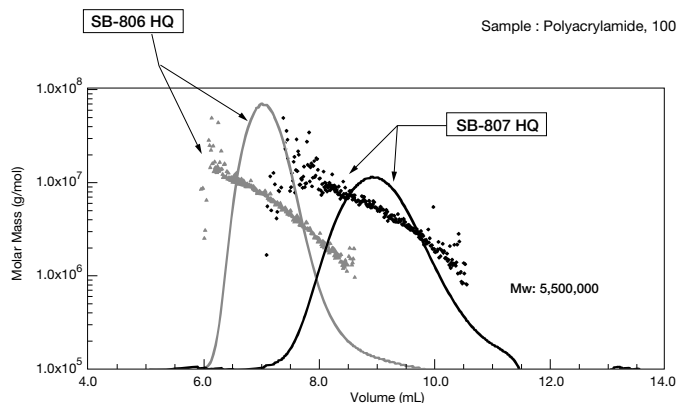

**Column** : Shodex OHpak SB-807 HQ, SB-806 HQ  
**Eluent** : 0.2 M NaCl aq.  
**Flow rate** : 0.5 mL/min  
**Detector** : RI  
 MALS (Multi angle light scattering)  
**Column temp.** : 30 °C

**Cellulose acetate**

Sample : Cellulose acetate 0.1 % each, 100 µL

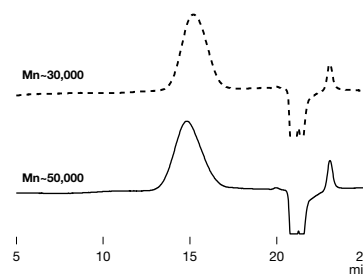

**Column** : Shodex OHpak SB-806M HQ x 2  
**Eluent** : 20 mM LiBr in DMF  
**Flow rate** : 1.0 mL/min  
**Detector** : RI  
**Column temp.** : 40 °C

### Copovidones

Sample : 100  $\mu$ L  
Poly(1-vinylpyrrolidone-co-vinyl acetate) 0.1 % each

Copolymer 7:3

Mn : 2,000  
Mw : 14,400  
Mw/Mn : 7.40

Copolymer 3:7

Mn : 6,400  
Mw : 28,900  
Mw/Mn : 4.53

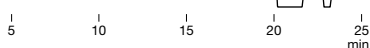

Molecular weight was determined from the calibration curve of PEG/P EO.

**Column** : Shodex OHpak SB-806M HQ x 2  
**Eluent** : 20 mM LiBr in DMF  
**Flow rate** : 1.0 mL/min  
**Detector** : RI  
**Column temp.** : 40  $^{\circ}$ C

### Calibration curves for LB-800 series using pullulan (eluent: H<sub>2</sub>O)

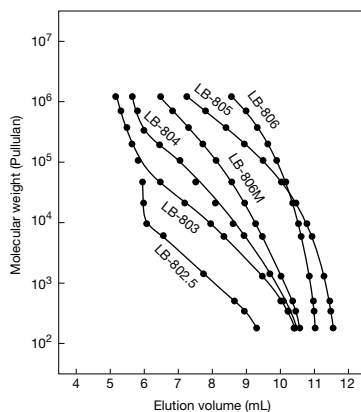

**Column** : Shodex OHpak LB-800 series  
**Eluent** : H<sub>2</sub>O  
**Flow rate** : 1.0 mL/min  
**Detector** : RI  
**Column temp.** : 30  $^{\circ}$ C

### Calibration curves for LB-800 series using PEG/PEO (eluent: DMF)

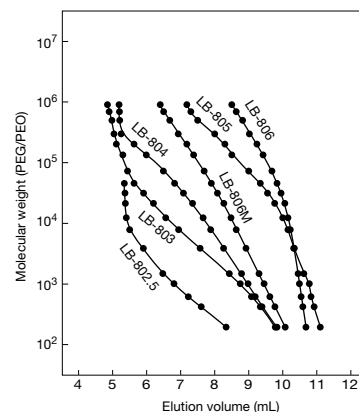

**Column** : Shodex OHpak LB-800 series  
**Eluent** : DMF  
**Flow rate** : 1.0 mL/min  
**Detector** : RI  
**Column temp.** : 40  $^{\circ}$ C

### Comparison of pullulan detection using multi angle light scattering detector

The OHpak LB-800 series is able to detect low molecular weight substances owing to its improved low baseline noise level while using it with a multiangle light scattering detector. This cannot be achieved with other manufacturer's SEC column.

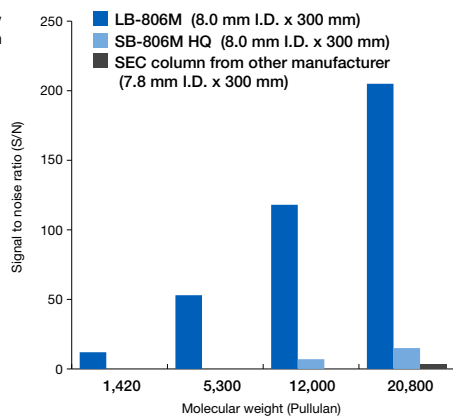
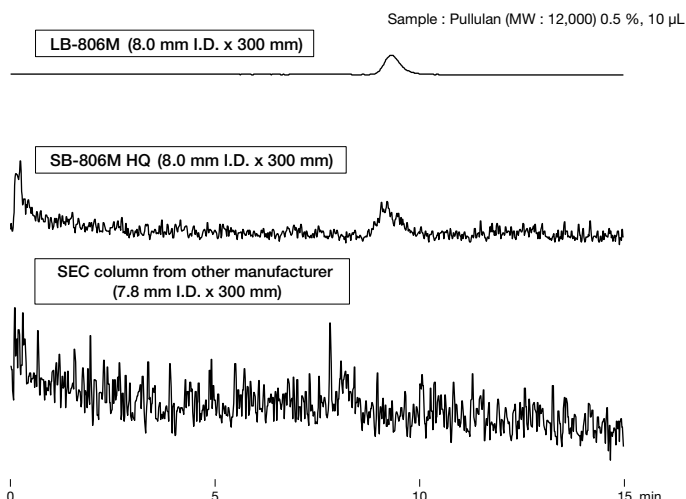

**Column** : Shodex OHpak LB-806M  
Shodex OHpak SB-806M HQ  
SEC column from other manufacturer (7.8 mm I.D. x 300 mm)  
**Eluent** : 0.1 M NaNO<sub>3</sub> aq.  
**Flow rate** : 1.0 mL/min  
**Detector** : MALS (Multi angle light scattering) (90  $^{\circ}$ )  
**Column temp.** : 30  $^{\circ}$ C

### Sodium alginate

Sample : Sodium alginate 0.1 % , 100  $\mu$ L

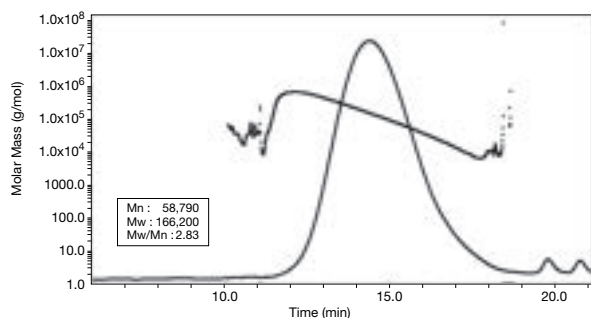

Mn : 58,790  
Mw : 166,200  
Mw/Mn : 2.83

**Column** : Shodex OHpak LB-806M x 2  
**Eluent** : 0.1 M NaNO<sub>3</sub> aq.  
**Flow rate** : 1.0 mL/min  
**Detector** : RI  
MALS (Multi angle light scattering)  
**Column temp.** : 30  $^{\circ}$ C

### Sodium heparin

Sample : Sodium heparin 0.1 % , 100  $\mu$ L

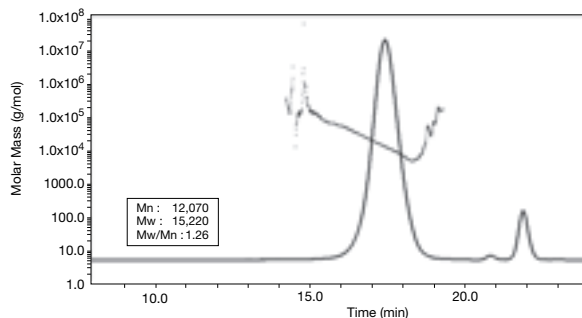

Mn : 12,070  
Mw : 15,220  
Mw/Mn : 1.26

**Column** : Shodex OHpak LB-806M x 2  
**Eluent** : 0.1 M NaNO<sub>3</sub> aq.  
**Flow rate** : 1.0 mL/min  
**Detector** : RI  
MALS (Multi angle light scattering)  
**Column temp.** : 30  $^{\circ}$ C

# Multimode Columns

## Features

### GS-HQ

- SEC is the main separation mode
- With the choice of eluent, the column provides multimode features of reversed phase, HILIC, and ion exchange modes to SEC
- Suitable for the separation of peptides or nucleic acids with similar molecular weights
- Suitable for desalting samples or substituting buffer in protein analysis

### Standard columns

Product Code	Product Name	Plate Number (TP/column)	Particle Size (µm)	Pore Size (Å)	Column Size (mm) I.D. x Length	Shipping Solvent
F7600005	<b>Asahipak GS-220 HQ</b>	≥ 19,000	6	150	<b>7.5 x 300</b>	H <sub>2</sub> O/CH <sub>3</sub> OH = 70/30
F7600006	<b>Asahipak GS-320 HQ</b>	≥ 19,000	6	400	<b>7.5 x 300</b>	H <sub>2</sub> O/CH <sub>3</sub> OH = 70/30
F6710019	<b>Asahipak GS-2G 7B</b>	(guard column)	9	—	<b>7.5 x 50</b>	H <sub>2</sub> O/CH <sub>3</sub> OH = 70/30

Base Material: Polyvinyl alcohol  
Usable pH Range: pH2 - 9 (GS-220 HQ)  
pH2 - 12 (GS-320 HQ)

### Preparative columns [Preparative columns are made to order]

Product Code	Product Name	Plate Number (TP/column)	Particle Size (µm)	Column Size (mm) I.D. x Length	Shipping Solvent	Standard Column
F6810034	<b>Asahipak GS-220 20G</b>	≥ 14,000	13	<b>20.0 x 500</b>	H <sub>2</sub> O/CH <sub>3</sub> OH = 70/30	GS-220 HQ
F6810035	<b>Asahipak GS-320 20G</b>	≥ 14,000	13	<b>20.0 x 500</b>	H <sub>2</sub> O/CH <sub>3</sub> OH = 70/30	GS-320 HQ
F6710021	<b>Asahipak GS-20G 7B</b>	(guard column)	20	<b>7.5 x 50</b>	H <sub>2</sub> O/CH <sub>3</sub> OH = 70/30	(guard column)

Base Material: Polyvinyl alcohol

### Usable solvents

Product Name	Maximum Usable Concentration (%)	
	Methanol	Acetonitrile
<b>GS-220 HQ</b>	30	50
<b>GS-320 HQ</b>	100	50

### Target molecular weight range and exclusion limit

#### Measured with pullulan (eluent: ultrapure water)

Product Name	Target Molecular Weight Range	Exclusion Limit
<b>GS-220 HQ</b>	300 - 3,000	7,000
<b>GS-320 HQ</b>	300 - 20,000	40,000

Please use the above table for reference purposes only when selecting columns.

Calibration curves for GS-HQ series using pullulan

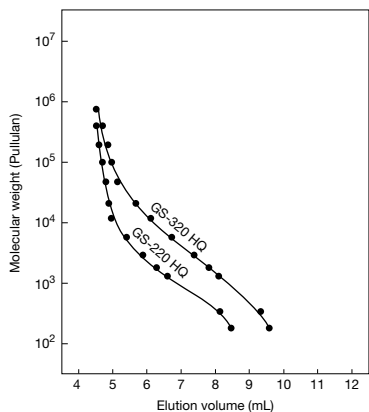

Column : Shodex Asahipak GS-HQ series  
 Eluent : H<sub>2</sub>O  
 Flow rate : 0.6 mL/min  
 Detector : RI  
 Column temp. : 30 °C

Peptides

GS-HQ columns work not only under SEC (GFC) mode, but also under multimode, adding hydrophobic and ionic interactions. By carefully selecting the eluent, they provide separation mode that was not available with other types of columns. GS-320 HQ shows excellent performance separating hydrophilic peptides, particularly for acidic and basic peptides.

	MW	pI	Σ f
Glu-Ala-Glu	347	3.12	0.39
Arg-Asp	289	6.75	0.68
Gly-His-Lys	340	9.95	0.29
Arg-Pro-Lys-Pro	497	11.44	3.24

Σ f : Hydrophobic parameter  
 pI : Isoelectric point

Column : Shodex Asahipak GS-320 HQ  
 Eluent : 30 mM Ammonium acetate buffer (pH6.7)  
 Flow rate : 0.5 mL/min  
 Detector : UV (220 nm)  
 Column temp. : 30 °C

Sample : 20 µL  
 1. Glu-Ala-Glu 0.025 %  
 2. Arg-Asp 0.05 %  
 3. Gly-His-Lys 0.025 %  
 4. Arg-Pro-Lys-Pro 0.025 %

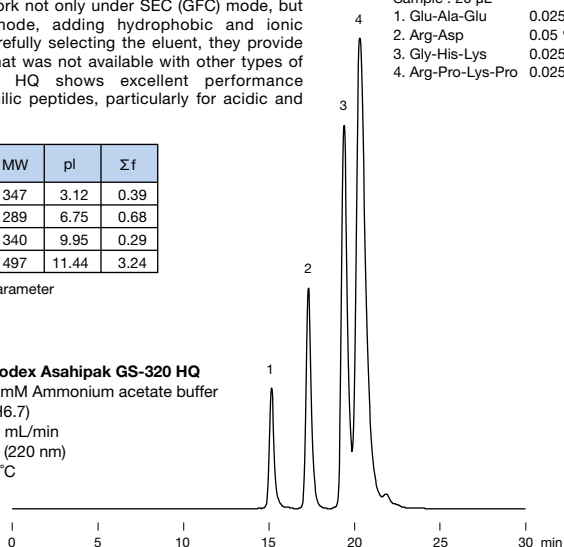

Purine bases in beer

Purine in food is analyzed as purine base after steps of sample preparation; homogenization, freeze drying, hydrolyzation with 70 % perchloric acid, and neutralization. Example below shows the analysis of purine in regular beer and beer treated with guanase (an enzyme that degrades guanine to xanthine). The following data indicate that guanine was decreased and xanthine was increased by guanase.

Purine base standards

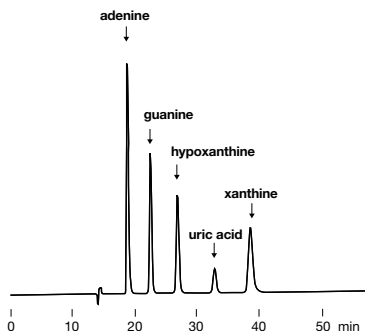

Normal beer

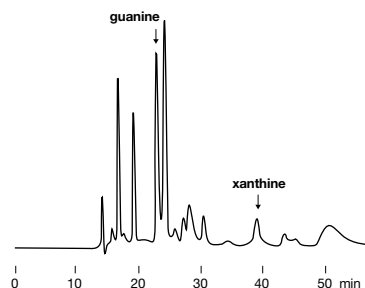

Guanase treated beer

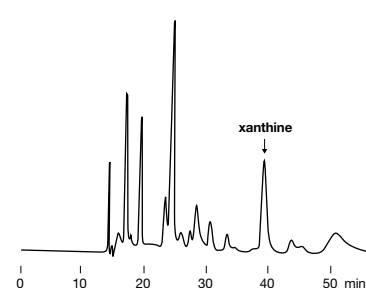

Column : Shodex Asahipak GS-320 HQ  
 Eluent : 150 mM Sodium phosphate buffer (pH2.5)  
 Flow rate : 0.6 mL/min  
 Detector : UV (260 nm)  
 Column temp. : 35 °C

Data provided by Kiyoko Kaneko Ph.D.,  
 Faculty of Pharmaceutical Sciences, Teikyo University

Low molecular weight water-soluble dietary fiber

GS-220 HQ allows to elute monosaccharides, disaccharides, and sugar alcohols after the indigestible component fraction (indicated by an arrow on the chromatogram). This separation makes the method preferable for the quantification of low molecular weight water-soluble dietary fiber.

Sample : 20 µL  
 Low molecular weight water soluble dietary fiber

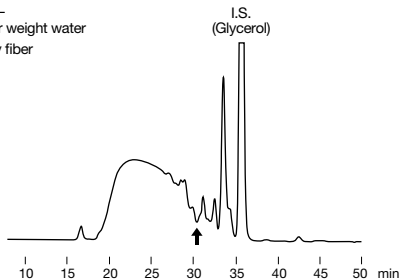

Column : Shodex Asahipak GS-220 HQ x 2  
 Eluent : H<sub>2</sub>O  
 Flow rate : 0.5 mL/min  
 Detector : RI  
 Column temp. : 60 °C

“Umami”

Sample : 50 µg/mL each, 20 µL  
 1. IMP  
 2. GMP  
 3. AMP  
 4. Inosine  
 5. Hypoxanthine  
 6. Guanosine  
 7. Guanine  
 8. Adenosine  
 9. Adenine

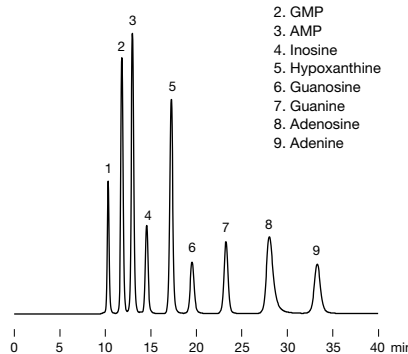

Column : Shodex Asahipak GS-320 HQ  
 Eluent : 10 mM NaH<sub>2</sub>PO<sub>4</sub> aq./10 mM Na<sub>2</sub>HPO<sub>4</sub> aq. = 1000/31  
 Flow rate : 1.0 mL/min  
 Detector : UV (260 nm)  
 Column temp. : 40 °C

# Aqueous-Organic SEC Columns

## Features

### GF-HQ

- Polymer-based SEC columns with high solvent durability
- Works well with both aqueous and organic solvents

### • Standard columns

Product Code	Product Name	Plate Number (TP/column)	Particle Size (μm)	Pore Size (Å)	Column Size (mm) I.D. x Length	Shipping Solvent
F7600000	<b>Asahipak GF-210 HQ</b>	≥ 19,000	5	180	<b>7.5 x 300</b>	H <sub>2</sub> O
F7600001	<b>Asahipak GF-310 HQ</b>	≥ 19,000	5	400	<b>7.5 x 300</b>	H <sub>2</sub> O/CH <sub>3</sub> OH = 70/30
F7600002	<b>Asahipak GF-510 HQ</b>	≥ 19,000	5	2,000	<b>7.5 x 300</b>	H <sub>2</sub> O/CH <sub>3</sub> OH = 70/30
F7600004	<b>Asahipak GF-7M HQ</b>	≥ 13,000	9	10,000	<b>7.5 x 300</b>	H <sub>2</sub> O/CH <sub>3</sub> OH = 70/30
F6710018	<b>Asahipak GF-1G 7B</b>	(guard column)	9	—	<b>7.5 x 50</b>	H <sub>2</sub> O/CH <sub>3</sub> OH = 70/30
F7600110	<b>MSPak GF-310 4D</b>	≥ 10,000	5	400	<b>4.6 x 150</b>	H <sub>2</sub> O

GF-7M HQ is a mixed-gel column capable of analyzing samples over a wide range of molecular weight.

Base Material: Polyvinyl alcohol  
Usable pH Range: pH2 - 9

### • Preparative columns [Preparative columns are made to order]

Product Code	Product Name	Plate Number (TP/column)	Particle Size (μm)	Column Size (mm) I.D. x Length	Shipping Solvent	Standard Column
F6810038	<b>Asahipak GS-310 20G</b>	≥ 14,000	13	<b>20.0 x 500</b>	H <sub>2</sub> O/CH <sub>3</sub> OH = 70/30	GF-310 HQ
F6810039	<b>Asahipak GS-510 20G</b>	≥ 14,000	13	<b>20.0 x 500</b>	H <sub>2</sub> O/CH <sub>3</sub> OH = 70/30	GF-510 HQ
F6710020	<b>Asahipak GS-10G 7B</b>	(guard column)	20	<b>7.5 x 50</b>	H <sub>2</sub> O/CH <sub>3</sub> OH = 70/30	(guard column)

Base Material: Polyvinyl alcohol

### Usable solvents

Solvent	Product Name		Solvent	Product Name	
	GF-210 HQ	GF-310 HQ GF-510 HQ GF-7M HQ		GF-210 HQ	GF-310 HQ GF-510 HQ GF-7M HQ
Water (0 - 0.5 M salt concentration)	✓	✓	N,N-Dimethylformamide (DMF)	✓	✓
Methanol	✓	✓	Acetone	✓	✓
Ethanol	✓	✓	Chloroform	✓	✓
Acetonitrile	✓	✓	Ethylacetate	✓	✓
Tetrahydrofuran (THF)	✓	✓	Dimethyl sulfoxide (DMSO)	✓	△

✓ : Solvent replacement possible    △: Solvent replacement possible up to 50 %

### Target molecular weight range and exclusion limit

#### • Measured with pullulan (eluent: ultrapure water)

Product Name	Target Molecular Weight Range	Exclusion Limit
<b>GF-210 HQ</b>	300 - 4,000	9,000
<b>GF-310 HQ</b>	300 - 30,000	40,000
<b>GF-510 HQ</b>	5,000 - 200,000	300,000
<b>GF-7M HQ</b>	300 - * (10,000,000)	* (10,000,000)

Please use the above table for reference purposes only when selecting columns.

\* ( ) Estimated value

#### • Measured with \*PEG/PEO (eluent: DMF)

Product Name	Target Molecular Weight Range
<b>GF-210 HQ</b>	100 - 2,000
<b>GF-310 HQ</b>	200 - 4,000
<b>GF-510 HQ</b>	2,000 - 200,000
<b>GF-7M HQ</b>	200 - ** (10,000,000)

Please use the above table for reference purposes only when selecting columns.

\*PEG: Polyethylene glycol  
\*PEO: Polyethylene oxide  
\*\* ( ) Estimated value

**Calibration curves for GF-HQ series using pullulan (eluent: H<sub>2</sub>O)**

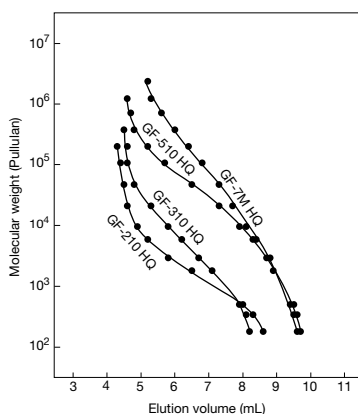

**Column** : Shodex Asahipak GF-HQ series  
**Eluent** : H<sub>2</sub>O  
**Flow rate** : 0.6 mL/min  
**Detector** : RI  
**Column temp.** : 30 °C

**Calibration curves for GF-HQ series using PEG/PEO (eluent: DMF)**

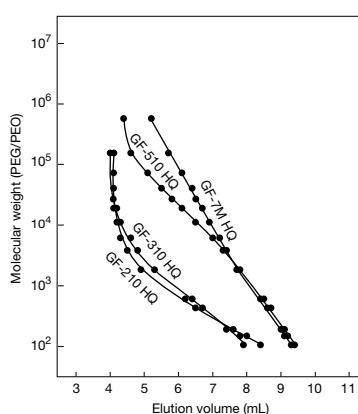

**Column** : Shodex Asahipak GF-HQ series  
**Eluent** : DMF  
**Flow rate** : 0.6 mL/min  
**Detector** : RI  
**Column temp.** : 40 °C

**Sodium polystyrene sulfonates**

Polymers having both hydrophobic and hydrophilic functional groups may exhibit hydrophobic interactions with packing materials. When analyzing such polymers, addition of organic solvents to the eluent can suppress the hydrophobic interaction.

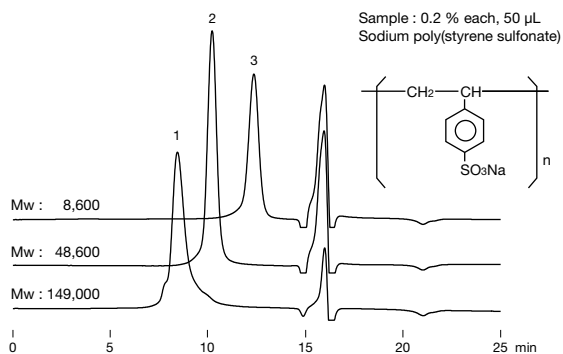

**Column** : Shodex Asahipak GF-510 HQ  
**Eluent** : 50 mM LiCl aq./CH<sub>3</sub>CN = 60/40  
**Flow rate** : 0.6 mL/min  
**Detector** : UV (254 nm)  
**Column temp.** : 30 °C

**Biodegradable Polymer**

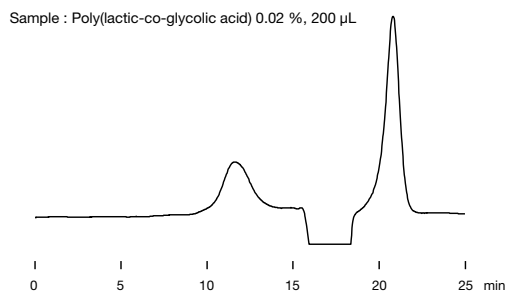

**Column** : Shodex Asahipak GF-7M HQ  
**Eluent** : CH<sub>3</sub>CN  
**Flow rate** : 0.6 mL/min  
**Detector** : RI  
**Column temp.** : 40 °C

**Comparison of two GF column performances for the separation of malto oligosaccharides**

GF-210 HQ demonstrates an improved separation of low molecular substances. The chromatograms below show that the peaks obtained by GF-210 HQ are separated with deeper notches compared to peaks obtained by GF-310 HQ. GF-210 HQ is capable of separating oligosaccharides (trisaccharide to hexasaccharide) while those oligosaccharides were eluted all together when analyzed by GF-310 HQ.

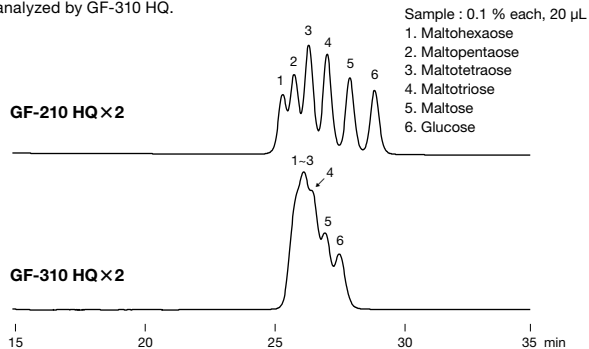

**Column** : Shodex Asahipak GF-210 HQ x 2  
 Shodex Asahipak GF-310 HQ x 2  
**Eluent** : H<sub>2</sub>O  
**Flow rate** : 0.6 mL/min  
**Detector** : RI  
**Column temp.** : 50 °C

**Comparison of polystyrene separation under three different solvent conditions**

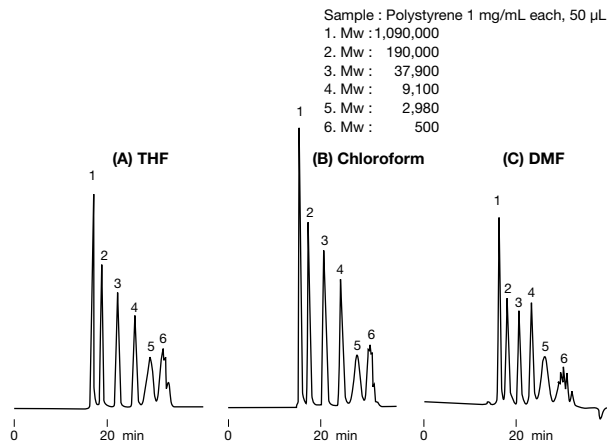

**Column** : Shodex Asahipak GF-510 HQ + GF-310 HQ  
**Eluent** : (A); THF, (B); Chloroform, (C); DMF  
**Flow rate** : 0.5 mL/min  
**Detector** : (A),(B) UV (254 nm), (C) UV (270 nm)  
**Column temp.** : 30 °C



# Organic SEC (GPC) Columns: General Analysis (THF)

## Features

- KF-800**
- Standard organic solvent SEC (GPC) column
  - Supports a wide range of applications from low to high molecular weight compounds
  - Fulfills USP-NF L21 requirements

### • Standard columns

Product Code	Product Name	Plate Number (TP/column)	Particle Size (µm)	Pore Size (Å)	Column Size (mm) I.D. x Length
F6028010	GPC KF-801	≥ 18,000	6	50	8.0 x 300
F6028020	GPC KF-802	≥ 18,000	6	150	8.0 x 300
F6028025	GPC KF-802.5	≥ 18,000	6	300	8.0 x 300
F6028030	GPC KF-803	≥ 18,000	6	500	8.0 x 300
F6027030	GPC KF-803L	≥ 18,000	6	500	8.0 x 300
F6028040	GPC KF-804	≥ 18,000	7	1,500	8.0 x 300
F6027040	GPC KF-804L	≥ 18,000	7	1,500	8.0 x 300
F6028050	GPC KF-805	≥ 11,000	10	5,000	8.0 x 300
F6027050	GPC KF-805L	≥ 11,000	10	5,000	8.0 x 300
F6028090	GPC KF-806M	≥ 13,000	10	10,000	8.0 x 300
F6027060	GPC KF-806L	≥ 11,000	10	10,000	8.0 x 300
F6027070	GPC KF-807L	≥ 6,000	18	20,000	8.0 x 300
F6700300	GPC KF-G 4A	(guard column)	8	—	4.6 x 10

The columns with 'L' or 'M' at the end of column names are mixed-gel columns capable of analyzing samples over a wide range of molecular weight distribution. See page 60 for solvent replacement applicability of Organic SEC (GPC) columns.

Base Material: Styrene divinylbenzene copolymer  
Shipping Solvent: Tetrahydrofuran (THF)

### Target molecular weight range and exclusion limit

#### • Measured with polystyrene (eluent: THF)

Product Name	Target Molecular Weight Range	Exclusion Limit	Product Name	Target Molecular Weight Range	Exclusion Limit
KF-801	100 - 700	1,500	KF-804L	100 - 300,000	400,000
KF-802	300 - 3,000	5,000	KF-805	50,000 - 2,000,000	4,000,000
KF-802.5	300 - 8,000	20,000	KF-805L	300 - 2,000,000	4,000,000
KF-803	1,000 - 50,000	70,000	KF-806M	1,000 - * (20,000,000)	* (20,000,000)
KF-803L	100 - 50,000	70,000	KF-806L	300 - * (20,000,000)	* (20,000,000)
KF-804	7,000 - 300,000	400,000	KF-807L	300 - * (200,000,000)	* (200,000,000)

Please use the above tables for reference purposes only when selecting columns.

\* ( ) Estimated value

# Organic SEC (GPC) Columns: Solvent-Peak Separation

## Features

- KF-800D**
- Use this column in combination with a linear column
  - Accurate molecular weight distribution of polymers and oligomers are achieved by shifting the elutions of monomers, polymer additives, and solvent-peak in the lower molecular region

### • Solvent-peak separation column

Product Code	Product Name	Column Combination	Particle Size (µm)	Column Size (mm) I.D. x Length
F6709350	GPC KF-800D	KF-805L, 806L, 806M, 807L	10	8.0 x 100

Base Material: Styrene divinylbenzene copolymer  
Shipping Solvent: Tetrahydrofuran (THF)

## Calibration curves for KF-800 series using polystyrene

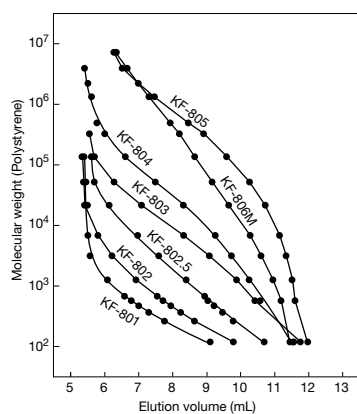

**Column** : Shodex GPC KF-800 series  
**Eluent** : THF  
**Flow rate** : 1.0 mL/min  
**Detector** : RI  
**Column temp.** : 40 °C

## Calibration curves for KF-800L (linear type) series using polystyrene

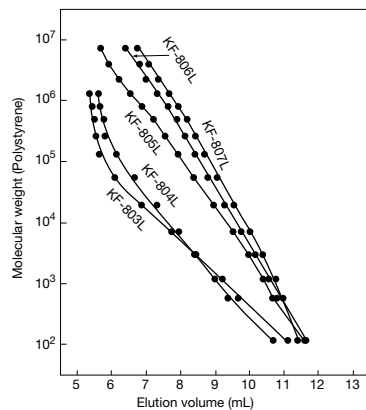

**Column** : Shodex GPC KF-800L series  
**Eluent** : THF  
**Flow rate** : 1.0 mL/min  
**Detector** : RI  
**Column temp.** : 40 °C

## Fat-soluble vitamins

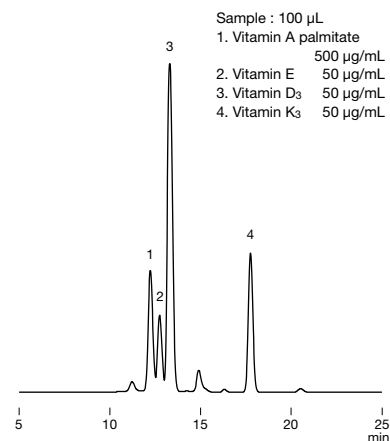

**Column** : Shodex GPC KF-801 x 2  
**Eluent** : THF  
**Flow rate** : 1.0 mL/min  
**Detector** : UV (280 nm)  
**Column temp.** : 40 °C

## Styrene isoprene ABA block copolymer

Sample : Styrene isoprene ABA block copolymer

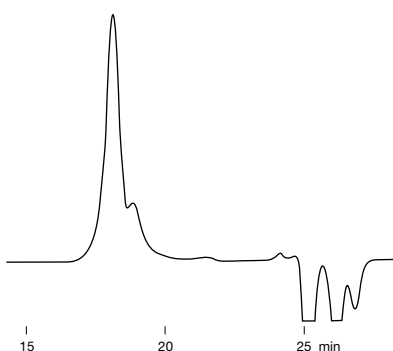

**Column** : Shodex GPC KF-806M x 2  
**Eluent** : THF  
**Flow rate** : 1.0 mL/min  
**Detector** : RI  
**Column temp.** : 30 °C

## Polycarbonate resin

Sample : Polycarbonate resin 0.1 %, 100  $\mu$ L

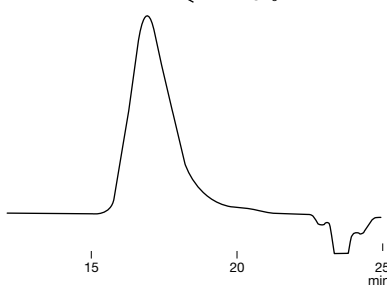
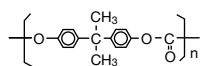

**Column** : Shodex GPC KF-806L x 2  
**Eluent** : THF  
**Flow rate** : 1.0 mL/min  
**Detector** : RI  
**Column temp.** : 40 °C

## Raw rubber

Sample : Rubber 0.1 %, 300  $\mu$ L

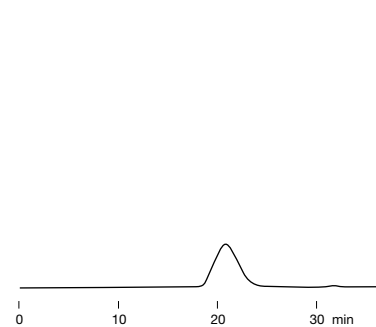

**Column** : Shodex GPC KF-806M x 2  
 + KF-802  
**Eluent** : Toluene  
**Flow rate** : 1.0 mL/min  
**Detector** : RI  
**Column temp.** : Room temp.

## Polylactic Acid

Sample : Polylactic acid 0.2 %, 50  $\mu$ L

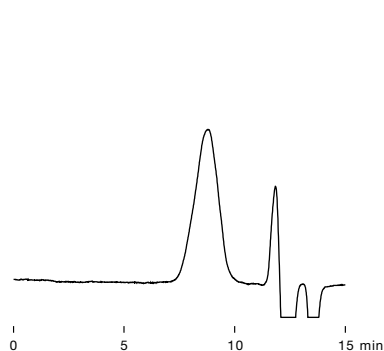

**Column** : Shodex GPC KF-806M  
**Eluent** : Chloroform  
**Flow rate** : 1.0 mL/min  
**Detector** : RI  
**Column temp.** : 30 °C

## Effects of solvent-peak separation column

Sample : Poly(vinyl chloride)

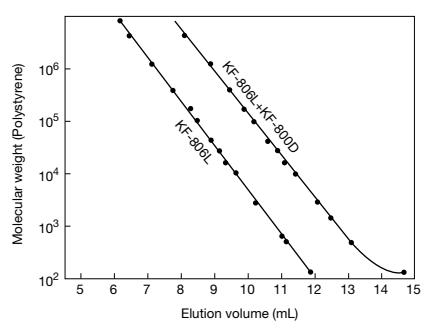
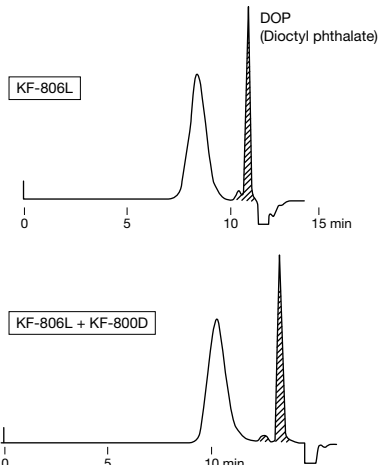

**Column** : Shodex GPC KF-806L  
 Shodex GPC KF-806L + KF-800D  
**Eluent** : THF  
**Flow rate** : 1.0 mL/min  
**Detector** : RI

# Organic SEC (GPC) Columns: General Analysis (DMF)

## Features

- **KD-800**
  - Standard organic solvent SEC (GPC) column
  - Supports a wide range of applications from low to high molecular weight compounds
  - Fulfills USP-NF L21 requirements

### • Standard columns [KD-800 series is made to order]

Product Code	Product Name	Plate Number (TP/column)	Particle Size (µm)	Pore Size (Å)	Column Size (mm) I.D. x Length
F6028210	<b>GPC KD-801</b>	≥ 17,000	6	50	<b>8.0 x 300</b>
F6028220	<b>GPC KD-802</b>	≥ 17,000	6	150	<b>8.0 x 300</b>
F6028225	<b>GPC KD-802.5</b>	≥ 17,000	6	300	<b>8.0 x 300</b>
F6028230	<b>GPC KD-803</b>	≥ 17,000	6	500	<b>8.0 x 300</b>
F6028240	<b>GPC KD-804</b>	≥ 17,000	7	1,500	<b>8.0 x 300</b>
F6028250	<b>GPC KD-805</b>	≥ 11,000	10	5,000	<b>8.0 x 300</b>
F6028260	<b>GPC KD-806</b>	≥ 11,000	10	10,000	<b>8.0 x 300</b>
F6028290	<b>GPC KD-806M</b>	≥ 13,000	10	10,000	<b>8.0 x 300</b>
F6028270	<b>GPC KD-807</b>	≥ 6,000	18	20,000	<b>8.0 x 300</b>
F6700411	<b>GPC KD-G 4A</b>	(guard column)	8	—	<b>4.6 x 10</b>

KD-806M is a mixed-gel column capable of analyzing samples over a wide range of molecular weight distribution. See page 60 for solvent replacement applicability of Organic SEC (GPC) columns.

Base Material: Styrene divinylbenzene copolymer  
Shipping Solvent: N,N-Dimethylformamide (DMF)

### Target molecular weight range and exclusion limit

#### • Measured with \*PEG/PEO (eluent: DMF)

Product Name	Target Molecular Weight Range	Exclusion Limit	Product Name	Target Molecular Weight Range	Exclusion Limit
<b>KD-801</b>	100 - 1,500	2,500	<b>KD-805</b>	30,000 - ** (4,000,000)	** (4,000,000)
<b>KD-802</b>	200 - 4,000	7,000	<b>KD-806</b>	30,000 - ** (40,000,000)	** (40,000,000)
<b>KD-802.5</b>	400 - 10,000	20,000	<b>KD-806M</b>	1,000 - ** (40,000,000)	** (40,000,000)
<b>KD-803</b>	1,000 - 50,000	70,000	<b>KD-807</b>	50,000 - ** (200,000,000)	** (200,000,000)
<b>KD-804</b>	4,000 - 200,000	200,000			

Please use the above tables for reference purposes only when selecting columns.

\*PEG: Polyethylene glycol

\*PEO: Polyethylene oxide

\*\* ( ) Estimated value

## Calibration curves for KD-800 series using PEG/PEO

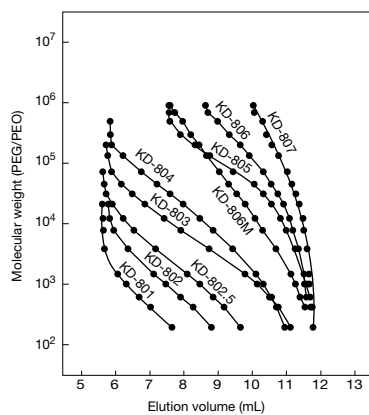

Column : Shodex GPC KD-800 series  
 Eluent : DMF  
 Flow rate : 1.0 mL/min  
 Detector : RI  
 Column temp. : 40 °C

## Polyvinylpyrrolidones

Sample : Polyvinylpyrrolidone 0.1 % each, 100  $\mu$ L

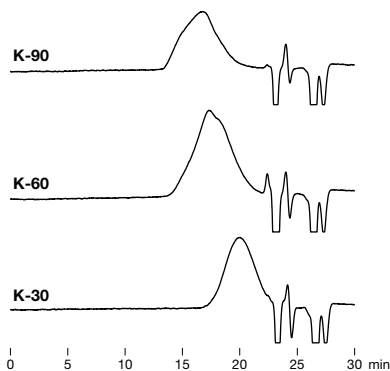

Column : Shodex GPC KD-806M x 2  
 Eluent : 10 mM LiBr in DMF  
 Flow rate : 1.0 mL/min  
 Detector : RI  
 Column temp. : 50 °C

## Melamine formaldehyde resin

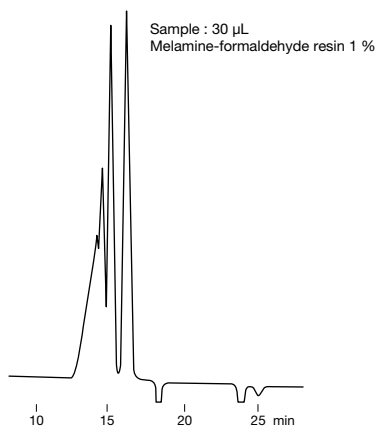

Column : Shodex GPC KD-802 x 2  
 Eluent : 10 mM LiBr in DMF  
 Flow rate : 1.0 mL/min  
 Detector : RI  
 Column temp. : 50 °C

## Celluloses

Sample : Cellulose ca. 0.05 % each, 100  $\mu$ L

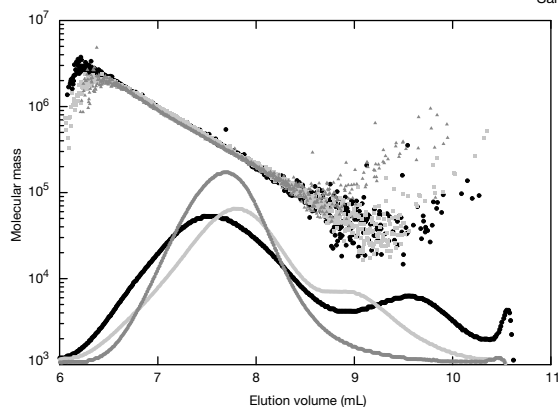

Cellulose is difficult to dissolve and repeated solvent replacement is required to prepare the cellulose solution. The time required to completely dissolve cellulose depends on the solvent type, crystallinity and molecular weight of the cellulose. This can be 1 to 60 days.

Column : Shodex GPC KD-806M  
 Eluent : 1 % LiCl in \*DMI  
 Flow rate : 0.5 mL/min  
 Detector : RI, MALS (Multi angle light scattering)  
 Column temp. : 60 °C

Data provided by Dr. Masahiko Yanagisawa,  
 Isogai group, Graduate School of Agricultural and  
 Life Sciences, The University of Tokyo

\*DMI: 1,3-dimethyl-2-imidazolidinone

## Potato starch

Sample : 100  $\mu$ L  
 Potato starch in DMSO 0.1 %  
 (dissolved at 80 °C)

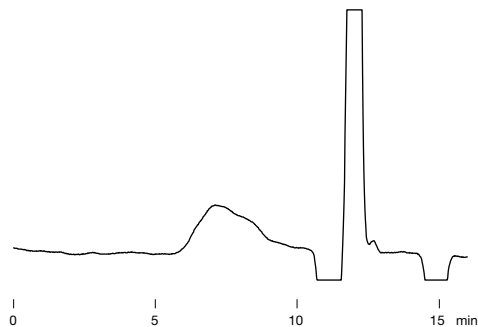

Column : Shodex GPC KD-806M  
 Eluent : 10 mM LiBr in DMSO/DMF = 75/25  
 Flow rate : 1.0 mL/min  
 Detector : RI  
 Column temp. : 50 °C

## Phenoxy resin

Sample : 250  $\mu$ L  
 Phenoxy resin 0.2 %

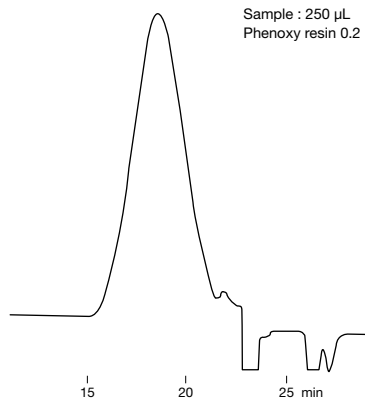

Column : Shodex GPC KD-806M x 2  
 Eluent : 10 mM in DMF  
 Flow rate : 1.0 mL/min  
 Detector : RI  
 Column temp. : 50 °C

# Organic SEC (GPC) Columns: High Performance Analysis

## Features

### KF-400HQ

- About 1.5 times better separation performance than standard columns, obtains higher resolution
- About 4 times better sensitivity than that of standard columns, supports high sensitivity analysis
- The amount of solvent used is reduced to about a third
- Improved applicability of solvent replacement
- Fulfills USP-NF L21 requirements

### • High performance semi-micro columns

\* KF-400HQ series is recommended to be used with semi-micro type devices.

Product Code	Product Name	Plate Number (TP/column)	Particle Size (μm)	Pore Size (Å)	Column Size (mm) I.D. x Length
F6028111	GPC KF-401HQ	≥ 25,000	3	50	4.6 x 250
F6028112	GPC KF-402HQ	≥ 25,000	3	150	4.6 x 250
F6028114	GPC KF-402.5HQ	≥ 25,000	3	300	4.6 x 250
F6028116	GPC KF-403HQ	≥ 25,000	3	500	4.6 x 250
F6700300	GPC KF-G 4A	(guard column)	8	—	4.6 x 10

See page 60 for solvent replacement applicability of Organic SEC (GPC) columns.

Base Material: Styrene divinylbenzene copolymer  
Shipping Solvent: Tetrahydrofuran (THF)

### Target molecular weight range and exclusion limit

#### • Measured with polystyrene (eluent: THF)

Product Name	Target Molecular Weight Range	Exclusion Limit
KF-401HQ	100 - 700	1,500
KF-402HQ	200 - 1,500	4,000
KF-402.5HQ	300 - 10,000	20,000
KF-403HQ	600 - 50,000	70,000

Please use the above tables for reference purposes only when selecting columns.

## Calibration curves for KF-400HQ series using polystyrene

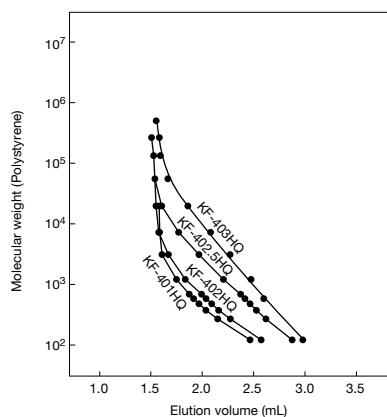

**Column** : Shodex GPC KF-400HQ series  
**Eluent** : THF  
**Flow rate** : 0.3 mL/min  
**Detector** : RI (small cell volume)  
**Column temp.** : 40 °C

## Liquid paraffin

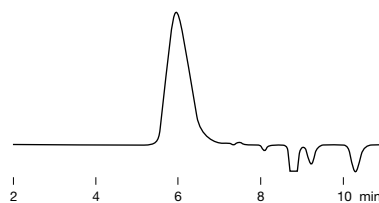
Sample : Liquid paraffin 1 %, 5  $\mu$ L

**Column** : Shodex GPC KF-401HQ  
**Eluent** : Chloroform  
**Flow rate** : 0.3 mL/min  
**Detector** : RI (small cell volume)  
**Column temp.** : 40 °C

## Phthalates

Sample : 10  $\mu$ L

1. Dioctyl phthalate 0.1 %
2. Dibutyl phthalate 0.1 %
3. Dipropyl phthalate 0.1 %
4. Diethyl phthalate 0.1 %
5. Dimethyl phthalate 0.1 %
6. Propylbenzene 0.2 %
7. Ethylbenzene 0.2 %
8. Toluene 0.2 %
9. Benzene 0.2 %

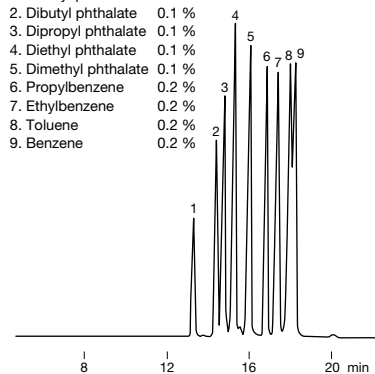

**Column** : Shodex GPC KF-401HQ x 2  
**Eluent** : THF  
**Flow rate** : 0.3 mL/min  
**Detector** : UV (254 nm) (small cell volume)  
**Column temp.** : 40 °C

## Comparison of standard and high performance type columns

(Standard type)  
 KF-802.5 x 2  
 50  $\mu$ L injection

(High performance type)  
 KF-402.5HQ x 2  
 10  $\mu$ L injection

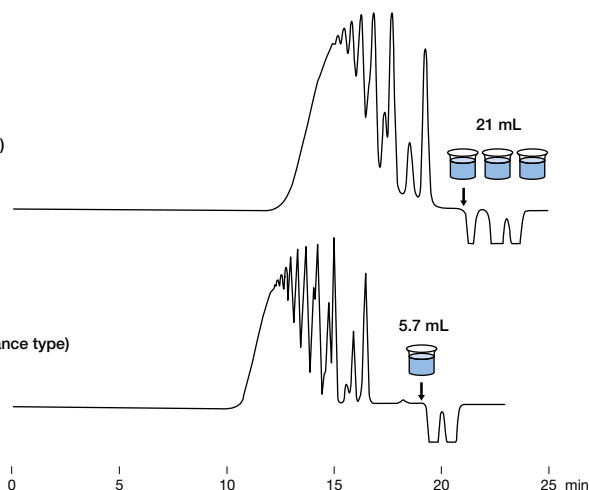

Sample : EPON1001 0.2 %

Having 1.5 times more theoretical plate number than standard column, KF-402.5HQ provides improved resolution especially for the separation of small to medium molecular weight substances. High performance type columns use less than one third of solvent per analysis compared to standard type columns do.

**Column** : Shodex GPC KF-802.5 x 2  
 Shodex GPC KF-402.5HQ x 2  
**Eluent** : THF  
**Flow rate** : 1.0 mL/min (KF-802.5)  
 0.3 mL/min (KF-402.5HQ)  
**Detector** : RI (conventional type) (KF-802.5)  
 RI (small cell volume) (KF-402.5HQ)  
**Column temp.** : 40 °C

## LC/MS analysis of antioxidant (IRGANOX 1010) in a cup of instant noodles (styrene foam)

Generally, pretreatment is required for additives analysis in polymers. By using a size exclusion chromatography column, it separates the additives from polymers, and only the low molecular weight region containing the additive is introduced into a mass spectrometer (MS). Therefore, sample pretreatment is not required, and thus a simple and rapid detection can be expected.

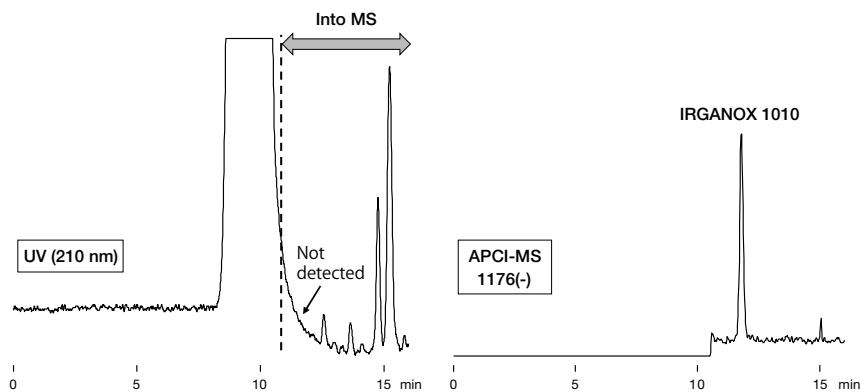

Sample : 5  $\mu$ L  
 Cup of instant noodles (styrene foam) 1000 mg/L

**Column** : Shodex GPC KF-402HQ x 2  
**Eluent** : THF  
**Flow rate** : 0.3 mL/min  
**Detector** : UV (210 nm), APCI-MS (SIM)  
**Column temp.** : 40 °C

# Organic SEC (GPC) Columns: Ultra-Rapid Analysis

## Features

### HK-400

- Newly developed styrene divinylbenzene copolymer monodisperse particles
- Analysis time is reduced to about a sixth of conventional column's analysis time
- Low column pressure even under high flow rate does not require a UHPLC system
- The amount of solvent used is reduced to about a sixth
- Fulfills USP-NF L21 requirements

### Ultra-Rapid analysis semi-micro columns

\* HK-400 series is recommended to be used with semi-micro type devices.

Product Code	Product Name	Plate Number (TP/column)	Particle Size (μm)	Pore Size (Å)	Column Size (mm) I.D. x Length
F6025010	GPC HK-401	≥ 9,000	3	50	4.6 x 150
F6025020	GPC HK-402	≥ 12,000	3	300	4.6 x 150
F6025030	GPC HK-403	≥ 9,000	3.5	550	4.6 x 150
F6026040	GPC HK-404L	≥ 9,000	3.5	2,000	4.6 x 150
F6025050	GPC HK-405	≥ 7,000	3	5,000	4.6 x 150
F6025060	GPC HK-406	≥ 5,000	6.5	10,000	4.6 x 150

HK-404L is a mixed-gel column capable of analyzing samples over a wide range of molecular weight distribution.

Base Material: Styrene divinylbenzene copolymer  
Shipping Solvent: Tetrahydrofuran (THF)

### Guard filter for HK series

Product Code	Product Name	Contents
F6700200	GPC HK-G	One holder and one filter
F6700100	GPC HK-G filter	3 filters

Removes sample-origin insoluble components.

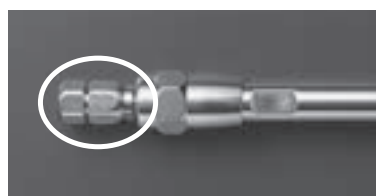

Attach directly to the analytical column.

### Usable solvents

Solvent	Product Name	
	HK-401 HK-403 HK-404L HK-405 HK-406	HK-402
Chloroform	✓	✓
N,N-Dimethylformamide (DMF)	✓	✓
Toluene	✓	✓
Hexafluoroisopropanol (HFIP)	✓	×
30 % HFIP/Chloroform	✓	✓

✓ : Solvent replacement possible    × : Solvent replacement not possible

### Target molecular weight range and exclusion limit

#### Measured with polystyrene (eluent: THF)

Product Name	Target Molecular Weight Range	Exclusion Limit
HK-401	100 - 1,500	2,000
HK-402	200 - 10,000	20,000
HK-403	2,000 - 70,000	100,000
HK-404L	100 - 1,000,000	1,000,000
HK-405	10,000 - 2,500,000	4,000,000
HK-406	30,000 - 8,000,000	10,000,000

Please use the above table for reference purposes only when selecting columns.



Calibration curves for HK-400 series using polystyrene (eluent : THF)

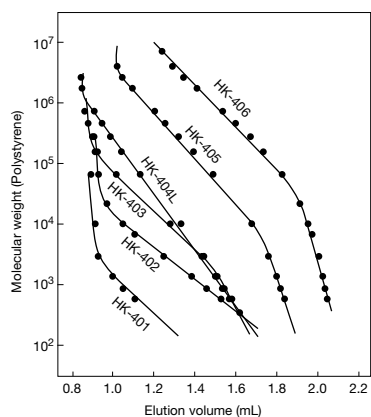

Column : Shodex GPC HK-400 series  
 Eluent : THF  
 Flow rate : 1.0 mL/min  
 Detector : RI (small cell volume)  
 Column temp. : 40 °C

Calibration curves for HK-400 series using PEG/PEO (eluent : DMF)

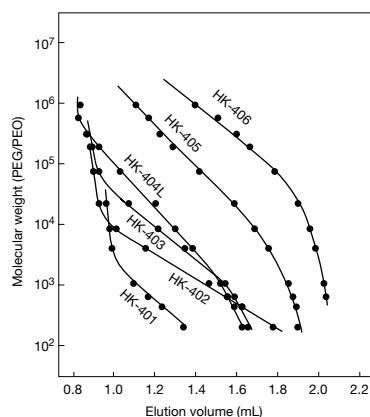

Column : Shodex GPC HK-400 series  
 Eluent : DMF  
 Flow rate : 1.0 mL/min (HK-402: 0.8 mL/min)  
 Detector : RI (small cell volume)  
 Column temp. : 40 °C

Calibration curve for HK-400 series using PMMA (eluent : HFIP)

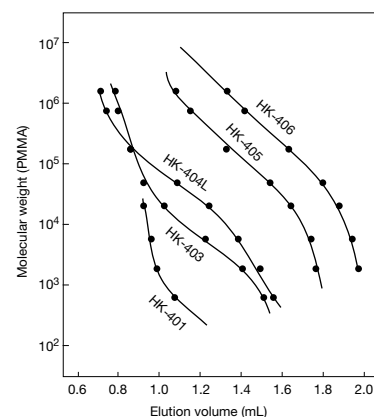

Column : Shodex GPC HK-400 series  
 Eluent : 5 mM CF<sub>3</sub>COONa in HFIP  
 Flow rate : 0.3 mL/min  
 Detector : RI (small cell volume)  
 Column temp. : 40 °C

Comparison of HK-404L and conventional column (KF-805L)

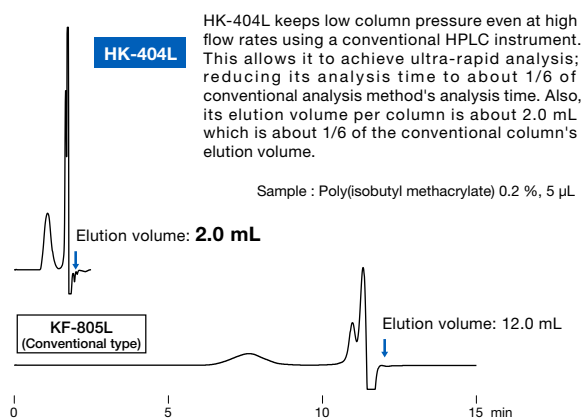

Column : Shodex GPC HK-404L, KF-805L  
 Eluent : THF  
 Flow rate : 1.0 mL/min  
 Detector : RI (small cell volume)  
 Column temp. : 40 °C

Poly (butyl methacrylate)

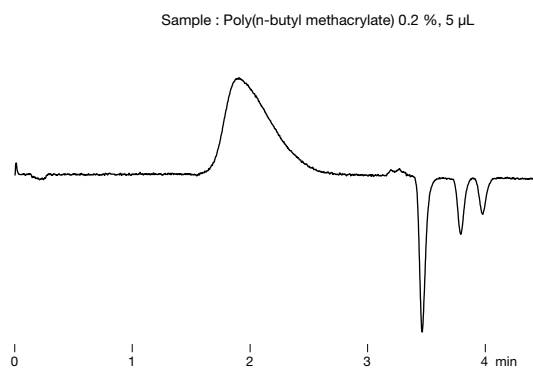

Column : Shodex GPC HK-404L x 2  
 Eluent : THF  
 Flow rate : 1.0 mL/min  
 Detector : RI (small cell volume)  
 Column temp. : 40 °C

Styrene butyl methacrylate copolymer

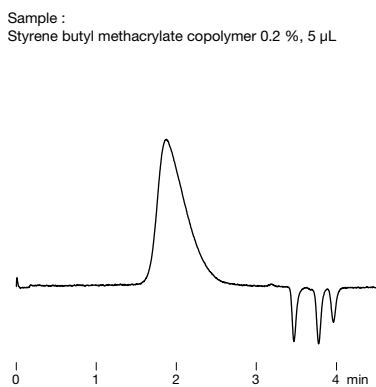

Column : Shodex GPC HK-404L x 2  
 Eluent : THF  
 Flow rate : 1.0 mL/min  
 Detector : RI (small cell volume)  
 Column temp. : 40 °C

Polyamide (Nylon 6/9)

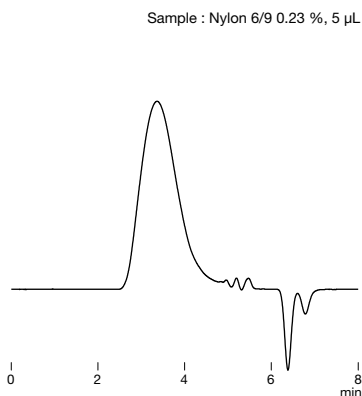

Column : Shodex GPC HK-404L  
 Eluent : 5 mM CF<sub>3</sub>COONa in HFIP  
 Flow rate : 0.3 mL/min  
 Detector : RI (small cell volume)  
 Column temp. : 40 °C

Polyamide (Nylon 11)

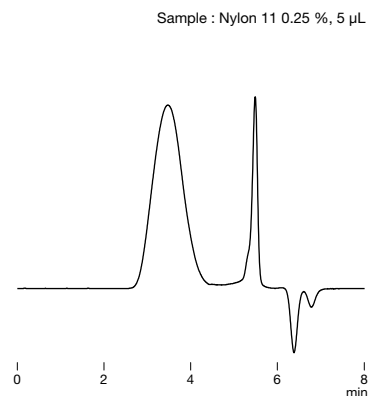

Column : Shodex GPC HK-404L  
 Eluent : 5 mM CF<sub>3</sub>COONa in HFIP  
 Flow rate : 0.3 mL/min  
 Detector : RI (small cell volume)  
 Column temp. : 40 °C

# Organic SEC (GPC) Columns: Linear Calibration Type

## Features

### LF

- Packed with unique multi-pore gels with a wide pore-size distribution
- Highly linear calibration curve without inflection points
- Achieves highly precise molecular weight distribution determination
- Enables analysis over a wide molecular weight range
- Rapid analysis column (LF-604) and high performance analysis column (LF-404) are also available
- LF-604 and LF-404 reduce solvent use
- Fulfills USP-NF L21 requirements

### • Standard columns

Product Code	Product Name	Plate Number (TP/column)	Particle Size (µm)	Pore Size (Å)	Column Size (mm) I.D. x Length
F6021041	<b>GPC LF-804</b>	≥ 17,000	6	3,000	<b>8.0 x 300</b>
F6709621	<b>GPC LF-G</b>	(guard column)	6	—	<b>4.6 x 10</b>

See page 60 for solvent replacement applicability of Organic SEC (GPC) columns.

Base Material: Styrene divinylbenzene copolymer  
Shipping Solvent: Tetrahydrofuran (THF)

### • Rapid analysis downsized columns

\* LF-604 is recommended to be used with semi-micro type devices.

Product Code	Product Name	Plate Number (TP/column)	Particle Size (µm)	Pore Size (Å)	Column Size (mm) I.D. x Length
F6021042	<b>GPC LF-604</b>	≥ 9,000	6	3,000	<b>6.0 x 150</b>
F6709621	<b>GPC LF-G</b>	(guard column)	6	—	<b>4.6 x 10</b>

See page 60 for solvent replacement applicability of Organic SEC (GPC) columns.

Base Material: Styrene divinylbenzene copolymer  
Shipping Solvent: Tetrahydrofuran (THF)

### • High performance semi-micro columns

\* LF-404 is recommended to be used with semi-micro type devices.

Product Code	Product Name	Plate Number (TP/column)	Particle Size (µm)	Pore Size (Å)	Column Size (mm) I.D. x Length
F6021043	<b>GPC LF-404</b>	≥ 14,000	6	3,000	<b>4.6 x 250</b>
F6709621	<b>GPC LF-G</b>	(guard column)	6	—	<b>4.6 x 10</b>

See page 60 for solvent replacement applicability of Organic SEC (GPC) columns.

Base Material: Styrene divinylbenzene copolymer  
Shipping Solvent: Tetrahydrofuran (THF)

## Target molecular weight range and exclusion limit

### • Measured with polystyrene (eluent: THF)

Product Name	Target Molecular Weight Range	Exclusion Limit
<b>LF-804</b>	300 - 2,000,000	2,000,000
<b>LF-604</b>	300 - 2,000,000	2,000,000
<b>LF-404</b>	300 - 2,000,000	2,000,000

Please use the above table for reference purposes only when selecting columns.

## Schematic diagram of linear calibration type packing

### Connecting linear calibration type columns (LF series)

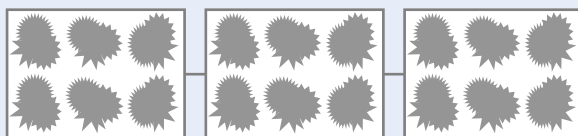

The linear calibration type column covers a broad range of molecular weights with only one kind of packing material.

### Connecting mixed-gel columns (KF-804L, etc.)

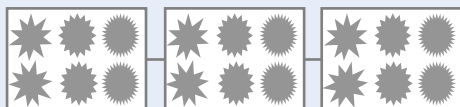

### Connecting different single pore-size columns (KF-804 + KF-803 + KF-802, etc.)



## Calibration curve for LF-804 using polystyrene

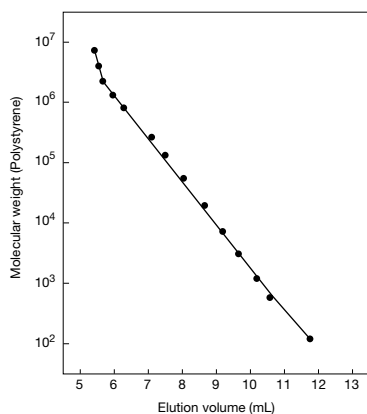

**Column** : Shodex GPC LF-804  
**Eluent** : THF  
**Flow rate** : 1.0 mL/min  
**Detector** : RI  
**Column temp.** : 40 °C

## Calibration curves for LF-604 and LF-404 using polystyrene

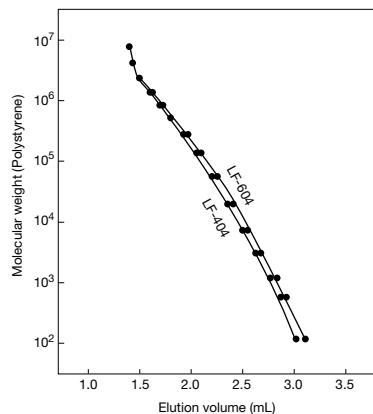

**Column** : Shodex GPC LF-604, LF-404  
**Eluent** : THF  
**Flow rate** : 0.5 mL/min (LF-604)  
 0.3 mL/min (LF-404)  
**Detector** : RI (small cell volume)  
**Column temp.** : 40 °C

## Polyurethane

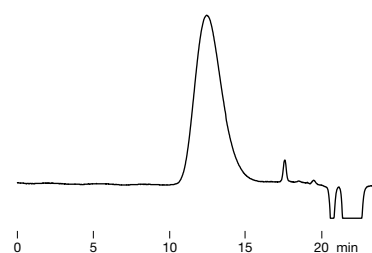
Sample : Polyurethane 0.1 %, 20  $\mu$ L

**Column** : Shodex GPC LF-404 x 2  
**Eluent** : THF  
**Flow rate** : 0.3 mL/min  
**Detector** : RI (small cell volume)  
**Column temp.** : 40 °C

## Xylan

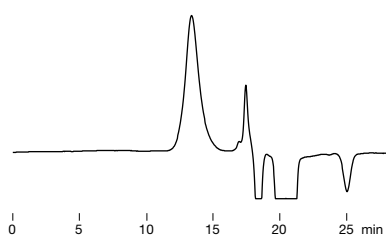
Sample : Xylan 0.1 %, 100  $\mu$ L

**Column** : Shodex GPC LF-804  
**Eluent** : 20 mM H<sub>3</sub>PO<sub>4</sub> + 20 mM LiBr  
 in DMSO/DMF = 80/20  
**Flow rate** : 0.6 mL/min  
**Detector** : RI  
**Column temp.** : 50 °C

## Polyamide (Nylon 6/6)

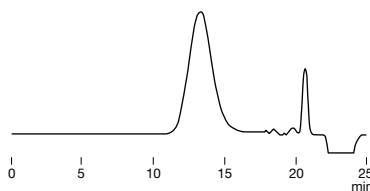
Sample : Nylon 6/6 0.1 %, 20  $\mu$ L

**Column** : Shodex GPC LF-404  
**Eluent** : 5 mM CF<sub>3</sub>COONa in HFIP  
**Flow rate** : 0.15 mL/min  
**Detector** : RI (small cell volume)  
**Column temp.** : 40 °C

## Polymethyl methacrylate

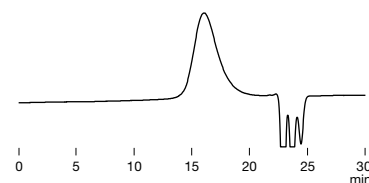
Sample : Polymethyl methacrylate, 100  $\mu$ L

**Column** : Shodex GPC LF-804 x 2  
**Eluent** : Methyl ethyl ketone  
**Flow rate** : 1.0 mL/min  
**Detector** : RI  
**Column temp.** : 40 °C

## Polyamic acid

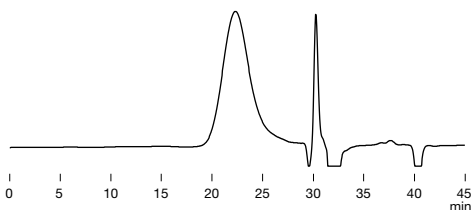
Sample : Poly(pyromellitic dianhydride-co-4,4'-oxydianiline), 100  $\mu$ L

**Column** : Shodex GPC LF-804 x 2  
**Eluent** : 30 mM LiBr + 30 mM H<sub>3</sub>PO<sub>4</sub> in NMP  
**Flow rate** : 0.7 mL/min  
**Detector** : RI  
**Column temp.** : 50 °C

## Effects of using multiple LF-404 columns on polystyrene separation



Sample : 10  $\mu$ L  
 1. Polystyrene (Mw : 1,030,000)  
 2. Polystyrene (Mw : 152,000)  
 3. Polystyrene (Mw : 66,000)  
 4. Polystyrene (Mw : 22,000)  
 5. Polystyrene (Mw : 5,050)  
 6. Polystyrene (Mw : 580)  
 7. Ethylbenzene

**Column** : Shodex GPC LF-404 x n  
**Eluent** : THF  
**Flow rate** : 0.3 mL/min  
**Detector** : RI (small cell volume)  
**Column temp.** : 40 °C

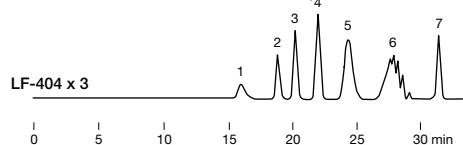

# Organic SEC (GPC) Column: Rapid Preparation

## Features

- Newly developed styrene divinylbenzene copolymer monodisperse particles
- Can deliver at four times higher flow rate (10 mL/min or more) compared with conventional products
- Achieves rapid recycling separation
- Suitable for the separation of samples in a wide molecular weight range due to its wide linear range and large pore volume
- Usable with various organic solvents such as THF, toluene, dichloroethane, ethyl acetate, DMF, and acetone used in GPC analysis in addition to chloroform

### FP-2002

- Preparative columns [Preparative columns are made to order]

Product Code	Product Name	Plate Number (TP/column)	Particle Size (μm)	Column Size (mm) I.D. x Length
F6102520	GPC FP-2002	≥ 30,000	8	20.0 x 600
F6700340	GPC FP-G 8B	(guard column)	8	8.0 x 50

Base Material: Styrene divinylbenzene copolymer  
Shipping Solvent: Chloroform

### Target molecular weight range and exclusion limit

- Measured with polystyrene (eluent: chloroform)

Product Name	Target Molecular Weight Range	Exclusion Limit
FP-2002	100 - 5,000	8,000

Please use the above for reference purpose only.

### Calibration curve for FP-2002 using polystyrene

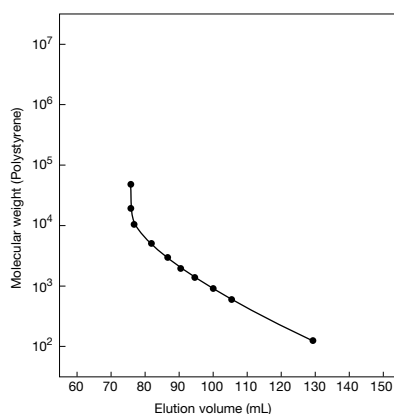

Column : Shodex GPC FP-2002  
Eluent : Chloroform  
Flow rate : 10 mL/min  
Detector : UV (254 nm)  
(preparative type)  
Column temp. : 30 °C

### Comparison of recycling separation

GPC FP-2002 is a column suitable for rapid organic solvent SEC(GPC) separation. Phthalate esters were used to compare recycled separations with other manufacturer's rapid preparative column (exclusion limit: 5,000). The recycling separation using FP-2002 can be made faster than other column for the same molecular weight range.

Sample : 10 % each, 2 mL  
1. Ditridecyl Phthalate (MW: 530)  
2. Bis(*trans*-3,3,5-trimethylcyclohexyl) phthalate (MW: 414)

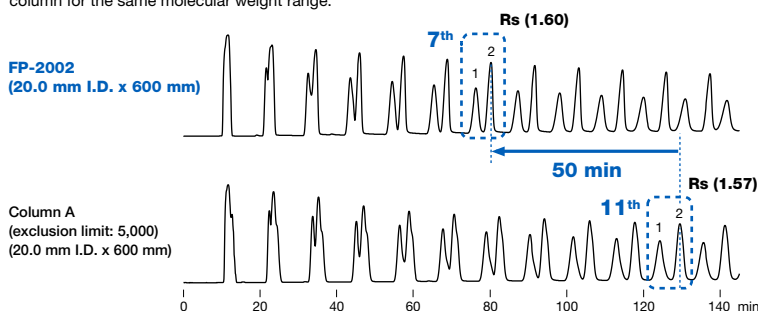

Column : Shodex GPC FP-2002  
Column A from other manufacturer  
Eluent : Chloroform  
Flow rate : 10 mL/min  
Detector : UV (254 nm) (preparative type)  
Column temp. : 30 °C

### Effects of flow rate for recycling separation

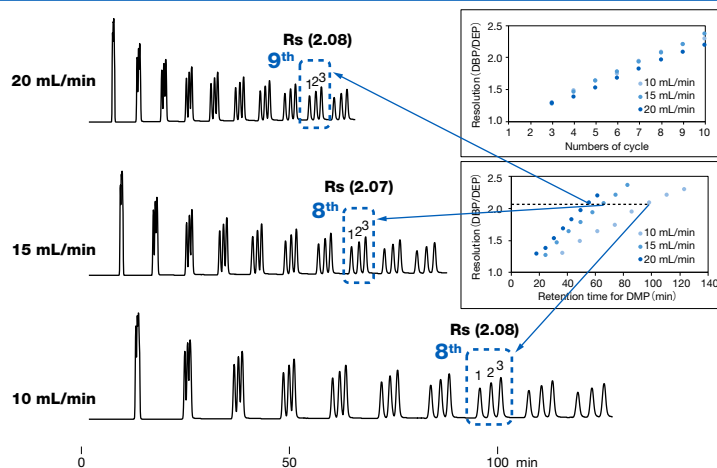

The standard flow rate of the packed column GPC FP-2002 for organic solvent-based SEC (GPC) is 10 mL/min. We have investigated the flow rate dependency of phthalate esters recycling separation. Even at the maximum usable flow rate of 20 mL/min, there is no extreme drop in column efficiency and further speeding up is possible.

(Note) In the case of a polymer sample, shear degradation of the polymer tends to occur as the molecular weight increases. It is recommended to lower the flow rate, if there is a possibility that shear degradation occurred.

Sample : 3 % each, 1 mL  
1. Dibutyl phthalate (DBP) (MW: 278)  
2. Diethyl phthalate (DEP) (MW: 222)  
3. Dimethyl phthalate (DMP) (MW: 194)

Column : Shodex GPC FP-2002  
Eluent : Chloroform  
Detector : UV (254 nm) (preparative type)  
Column temp. : 30 °C

# Organic SEC (GPC) Columns: Preparative

- **Preparative columns** [Preparative columns are made to order]

**GPC KF-2000 series** Shipping Solvent: Tetrahydrofuran (THF)

Product Code	Product Name	Plate Number (TP/column)	Particle Size (µm)	Column Size (mm) I.D. x Length	Standard Column
F6102401	<b>GPC KF-2001</b>	≥ 18,000	6	<b>20.0 x 300</b>	KF-801
F6102402	<b>GPC KF-2002</b>	≥ 18,000	6	<b>20.0 x 300</b>	KF-802
F6102425	<b>GPC KF-2002.5</b>	≥ 18,000	6	<b>20.0 x 300</b>	KF-802.5
F6102403	<b>GPC KF-2003</b>	≥ 18,000	6	<b>20.0 x 300</b>	KF-803
F6102404	<b>GPC KF-2004</b>	≥ 14,000	7	<b>20.0 x 300</b>	KF-804
F6102405	<b>GPC KF-2005</b>	≥ 10,000	10	<b>20.0 x 300</b>	KF-805
F6102406	<b>GPC KF-2006</b>	≥ 10,000	10	<b>20.0 x 300</b>	KF-806
F6102409	<b>GPC KF-2006M</b>	≥ 10,000	10	<b>20.0 x 300</b>	KF-806M
F6700406	<b>GPC KF-G 8B</b>	(guard column)	15	<b>8.0 x 50</b>	(guard column)

KF-2006M is a mixed-gel column capable of analyzing samples over a wide range of molecular weight distribution.

Base Material: Styrene divinylbenzene copolymer

**GPC K-2000 series** Shipping Solvent: Chloroform

Product Code	Product Name	Plate Number (TP/column)	Particle Size (µm)	Column Size (mm) I.D. x Length	Standard Column
F6102301	<b>GPC K-2001</b>	≥ 18,000	6	<b>20.0 x 300</b>	KF-801
F6102312	<b>GPC K-2002</b>	≥ 18,000	6	<b>20.0 x 300</b>	KF-802
F6102315	<b>GPC K-2002.5</b>	≥ 18,000	6	<b>20.0 x 300</b>	KF-802.5
F6102303	<b>GPC K-2003</b>	≥ 18,000	6	<b>20.0 x 300</b>	KF-803
F6102304	<b>GPC K-2004</b>	≥ 14,000	7	<b>20.0 x 300</b>	KF-804
F6102305	<b>GPC K-2005</b>	≥ 10,000	10	<b>20.0 x 300</b>	KF-805
F6102306	<b>GPC K-2006</b>	≥ 10,000	10	<b>20.0 x 300</b>	KF-806
F6102309	<b>GPC K-2006M</b>	≥ 10,000	10	<b>20.0 x 300</b>	KF-806M
F6700407	<b>GPC K-G 8B</b>	(guard column)	15	<b>8.0 x 50</b>	(guard column)

K-2006M is a mixed-gel column capable of analyzing samples over a wide range of molecular weight distribution.

Base Material: Styrene divinylbenzene copolymer

## [ Customized columns ]

**GPC H-2000 series** Shipping Solvent: Chloroform

Product Code	Product Name	Plate Number (TP/column)	Particle Size (µm)	Column Size (mm) I.D. x Length	Standard Column
F6102001	<b>GPC H-2001</b>	≥ 13,000	15	<b>20.0 x 500</b>	KF-801
F6102002	<b>GPC H-2002</b>	≥ 13,000	15	<b>20.0 x 500</b>	KF-802
F6102025	<b>GPC H-2002.5</b>	≥ 13,000	15	<b>20.0 x 500</b>	KF-802.5
F6102003	<b>GPC H-2003</b>	≥ 13,000	15	<b>20.0 x 500</b>	KF-803
F6102004	<b>GPC H-2004</b>	≥ 13,000	15	<b>20.0 x 500</b>	KF-804
F6102005	<b>GPC H-2005</b>	≥ 13,000	15	<b>20.0 x 500</b>	KF-805
F6102006	<b>GPC H-2006</b>	≥ 13,000	15	<b>20.0 x 500</b>	KF-806
F6102009	<b>GPC H-2006M</b>	≥ 12,000	15	<b>20.0 x 500</b>	KF-806M
F6700310	<b>GPC H-G 8B</b>	(guard column)	15	<b>8.0 x 50</b>	(guard column)

H-2006M is a mixed-gel column capable of analyzing samples over a wide range of molecular weight distribution.

Base Material: Styrene divinylbenzene copolymer

**GPC KF-5000 series** Shipping Solvent: Tetrahydrofuran (THF)

Product Code	Product Name	Particle Size (µm)	Column Size (mm) I.D. x Length	Standard Column
F6108010	<b>GPC KF-5001</b>	15	<b>50.0 x 300</b>	KF-801
F6108020	<b>GPC KF-5002</b>	15	<b>50.0 x 300</b>	KF-802
F6108025	<b>GPC KF-5002.5</b>	15	<b>50.0 x 300</b>	KF-802.5
F6108030	<b>GPC KF-5003</b>	15	<b>50.0 x 300</b>	KF-803
F6108040	<b>GPC KF-5004</b>	15	<b>50.0 x 300</b>	KF-804
F6700408	<b>GPC KF-G 20C</b>	15	<b>20.0 x 100</b>	(guard column)

Base Material: Styrene divinylbenzene copolymer

**GPC K-5000 series** Shipping Solvent: Chloroform

Product Code	Product Name	Particle Size (µm)	Column Size (mm) I.D. x Length	Standard Column
F6109010	<b>GPC K-5001</b>	15	<b>50.0 x 300</b>	KF-801
F6109020	<b>GPC K-5002</b>	15	<b>50.0 x 300</b>	KF-802
F6109025	<b>GPC K-5002.5</b>	15	<b>50.0 x 300</b>	KF-802.5
F6109030	<b>GPC K-5003</b>	15	<b>50.0 x 300</b>	KF-803
F6109040	<b>GPC K-5004</b>	15	<b>50.0 x 300</b>	KF-804
F6700409	<b>GPC K-G 20C</b>	15	<b>20.0 x 100</b>	(guard column)

Base Material: Styrene divinylbenzene copolymer

# Solvent Replacement Applicability of Organic SEC (GPC) Columns

Solvent	Product Name									
	Shipping Solvent : THF						Shipping Solvent : DMF			
	KF-801	KF-802 KF-802.5 KF-803L KF-804L	KF-803	KF-804 KF-805 KF-805L KF-806M KF-806L KF-807L	KF-401HQ KF-402HQ KF-402.5HQ	KF-403HQ	LF-804 LF-604 LF-404	KD-801 KD-802 KD-802.5	KD-803	KD-804 KD-805 KD-806 KD-807 KD-806M
Tetrahydrofuran (THF)	✓	✓	✓	✓	✓	✓	✓	×	×	✓
Chloroform	✓	✓	✓	✓	✓	✓	✓	×	×	✓
Carbon tetrachloride	×	✓	✓	✓			✓	×	×	✓
Benzene	✓	✓	✓	✓	✓	✓		×	✓	✓
Toluene	✓	✓	✓	✓	✓	✓	✓	×	✓	✓
p-Xylene	×	✓	✓	✓	✓	✓		×	✓	✓
o-Dichlorobenzene (ODCB)	×	×	✓	✓	✓	✓		×	✓	✓
1,2,4-Trichlorobenzene (TCB)	×	×	✓	✓	✓	✓		×	✓	✓
Dioxane	×	✓	✓	✓				×	✓	✓
Diethyl ether	×	×	✓	✓				×	✓	✓
Ethyl acetate	×	×	✓	✓				×	×	✓
Acetone	×	×	✓	✓	✓	✓	✓	×	✓	✓
Methyl ethyl ketone	×	×	✓	✓	✓	✓	✓	×	✓	✓
N,N-Dimethylformamide (DMF)	×	×	✓	✓	✓*	✓*	✓*	✓	✓	✓
N,N-Dimethylacetamide (DMAc)	×	×	✓	✓	✓*	✓*	✓*	×	✓	✓
Hexafluoroisopropanol (HFIP)	×	×	×	✓	×	△*	✓*	×	✓	✓
m-Cresol	×	×	✓	✓				×	✓	✓
o-Chlorophenol	×	×	✓	✓				×	✓	✓
Quinoline	×	×	✓	✓				×	✓	✓
N-Methyl-2-pyrrolidone (NMP)	×	×	✓	✓	✓*	✓*	✓*	×	✓	✓
Dimethyl sulfoxide (DMSO)	×	×	×	×	△*	✓*	✓*	×	×	✓
30 % m-Cresol/Chloroform	×	✓	✓	✓			✓	×	✓	✓
30 % o-Chlorophenol/Chloroform	×	✓	✓	✓			✓	×	✓	✓
30 % HFIP/Chloroform	×	✓	✓	✓				×	✓	✓
Hexane	×	×	×	×	×	×	×	×	×	×
Acetonitrile	×	×	×	×	×	×	×	×	×	×
Methanol	×	×	×	×	×	×	×	×	×	×
Water	×	×	×	×	×	×	×	×	×	×

✓ : Solvent replacement possible

△ : Solvent replacement possible, but this may cause column performance to deteriorate slightly

\* : Usable at 40 °C or higher

× : Solvent replacement not possible

See page 66 for solvent replacement method for Organic SEC (GPC) columns.

# Calibration Standards for SEC

When measuring molecular weight distribution of polymers using size exclusion chromatography (SEC), it is necessary to obtain a calibration curve using standard samples with known molecular weights.

Shodex STANDARDS are stable polymer standard samples with little branching and an extremely narrow molecular weight distribution. Shodex STANDARDS are proudly recommended for the preparation of calibration curves.

## Polystyrene (PS)

### Features

- SL-105**
  - For organic solvent SEC (GPC)
- SM-105**
  - Less branched polystyrene with anionic polymerization
- SH-75**
  - Easily soluble in tetrahydrofuran (THF), chloroform, toluene, and o-dichlorobenzene (ODCB)

### Standard kit

Product Code	Product Name	Contents	Molecular Weight (Mp) Range
F8601105	<b>STANDARD SL-105</b>	<b>0.5 g x 10 kinds</b>	580 - 18,000
F8602105	<b>STANDARD SM-105</b>	<b>0.5 g x 10 kinds</b>	1,180 - 3,210,000
F8603075	<b>STANDARD SH-75</b>	<b>0.5 g x 7 kinds</b>	662,000 - 6,550,000

### Structural formula of S series

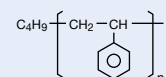

### ◆ SL-105

Std.No.	Mp	Mw/Mn
S-18	18,000	1.02
S-13	13,400	1.02
S-9.8	9,320	1.02
S-6.7	6,660	1.03
S-4.9	4,910	1.03
S-3.3	3,320	1.04
S-2.0	1,990	1.05
S-1.2	1,180	1.07
S-0.9	940	1.07
S-0.6	580	1.13

### ◆ SM-105

Std.No.	Mp	Mw/Mn
S-3210	3,210,000	1.06
S-1570	1,570,000	1.04
S-607	607,000	1.03
S-298	298,000	1.04
S-129	129,000	1.03
S-49	49,400	1.04
S-17	17,100	1.03
S-6.3	6,250	1.03
S-3.3	3,320	1.04
S-1.2	1,180	1.06

### ◆ SH-75

Std.No.	Mp	Mw/Mn
S-6550	6,550,000	1.07
S-3550	3,550,000	1.05
S-3020	3,020,000	1.03
S-2330	2,330,000	1.03
S-1860	1,860,000	1.04
S-885	885,000	1.05
S-662	662,000	1.04

(Note)  
Molecular weights (Mp, Mw/Mn) of each standard kit may vary depending on production lot.

## Polymethylmethacrylate (PMMA)

### Features

- M-75**
  - For organic solvent SEC (GPC)
  - Narrow molecular weight distribution range
  - Easily soluble in hexafluoroisopropanol (HFIP) and N,N-dimethylformamide (DMF)

### Standard kit

Product Code	Product Name	Contents	Molecular Weight (Mp) Range
F8604075	<b>STANDARD M-75</b>	<b>0.5 g x 7 kinds</b>	3,310 - 1,230,000

(Note)  
Molecular weights (Mp, Mw/Mn) of a standard kit may vary depending on production lot.

### ◆ M-75

Std.No.	Mp	Mw/Mn
M-1230	1,230,000	1.09
M-539	539,000	1.02
M-210	210,000	1.02
M-60	60,300	1.02
M-18	17,900	1.03
M-6.9	6,940	1.10
M-3.3	3,310	1.09

## Pullulan

### Features

- P-82**
  - For aqueous SEC (GFC)
  - Unbranched pullulan standard
  - High solubility in water eliminates the possibility of recrystallization

### Standard kit

Product Code	Product Name	Contents	Molecular Weight (Mp) Range
F8400000	<b>STANDARD P-82</b>	<b>0.2 g x 8 kinds</b>	6,400 - 692,000

(Note)  
Molecular weights (Mp, Mw/Mn) of a standard kit may vary depending on production lot.

### Structural formula of P series

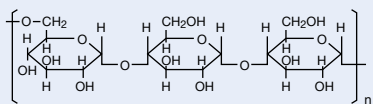

### ◆ P-82

Std.No.	Mp	Mw/Mn
P-800	692,000	1.30
P-400	354,000	1.22
P-200	218,000	1.16
P-100	110,000	1.12
P-50	49,400	1.08
P-20	21,900	1.10
P-10	9,800	1.07
P-5	6,400	1.08



# Anion Exchange Chromatography Columns

## Features

### QA-825

### DEAE-825

- Suitable for analyzing relatively high molecular weight compounds: proteins, peptides, DNA, and RNA
- Usable in a wide pH range from pH 2 to 12
- QA-825 fulfills USP-NF L23 requirements

### ES-502N 7C

- Compared to IEC series columns, polyvinyl alcohol is used as base material and this offers different separation pattern
- Low hydrophobic interaction of proteins allows analysis under mild conditions

### Strong anion exchange resin [Functional Group: Quaternary ammonium]

#### • Standard column

Product Code	Product Name	Ion Exchange Capacity (meq/g)	Base Material	Particle Size (µm)	Pore Size (Å)	Column Size (mm) I.D. x Length	Shipping Solvent
F6110011	IEC QA-825	0.45	Polyhydroxymethacrylate	12	5,000	8.0 x 75	50 mM Na <sub>2</sub> SO <sub>4</sub> aq.

### Weak anion exchange resin [Functional Group: Diethylaminoethyl]

#### • Standard columns

Product Code	Product Name	Ion Exchange Capacity (meq/g)	Base Material	Particle Size (µm)	Pore Size (Å)	Column Size (mm) I.D. x Length	Shipping Solvent
F6118255	IEC DEAE-825	0.6	Polyhydroxymethacrylate	8	5,000	8.0 x 75	50 mM Na <sub>2</sub> SO <sub>4</sub> aq.
F7640002	Asahipak ES-502N 7C	0.55	Polyvinyl alcohol	9	2,000	7.5 x 100	50 mM 1,3-Diaminopropane + 50 mM NaCl (pH10.0)

# Cation Exchange Chromatography Columns

## Features

### SP-825

### CM-825

- Suitable for analyzing relatively high molecular weight compounds: proteins, peptides, DNA, and RNA
- Usable in a wide pH range from pH 2 to 12

### SP-FT 4A

- Non-porous base material
- Provides ultra-rapid analysis using conventional devices

### ES-502C 7C

- Compared to IEC series columns, polyvinyl alcohol is used as base material offering different separation pattern
- Low hydrophobic interaction with proteins allows analysis under mild conditions

### P-421S

- Column for amino acids analysis by cation exchange mode
- Provides simultaneous analysis of different amino acids
- Fulfills USP-NF L22 and L58 requirements

### Strong cation exchange resin [Functional Group: Sulfoethyl]

#### • Standard columns

Product Code	Product Name	Ion Exchange Capacity (meq/g)	Base Material	Particle Size (µm)	Pore Size (Å)	Column Size (mm) I.D. x Length	Shipping Solvent
F6118250	IEC SP-825	0.4	Polyhydroxymethacrylate	8	5,000	8.0 x 75	50 mM Na <sub>2</sub> SO <sub>4</sub> aq.
F6113100	IEC SP-FT 4A	0.2	Polyhydroxymethacrylate	2.7	—	4.6 x 10	20 mM MES buffer (pH5.6)

Housing Material of SP-FT 4A: PEEK  
\*MES: 2-(N-Morpholino)ethanesulfonic acid

### Weak cation exchange resin [Functional Group: Carboxymethyl]

#### • Standard columns

Product Code	Product Name	Ion Exchange Capacity (meq/g)	Base Material	Particle Size (µm)	Pore Size (Å)	Column Size (mm) I.D. x Length	Shipping Solvent
F6110002	IEC CM-825	0.4	Polyhydroxymethacrylate	8	5,000	8.0 x 75	50 mM Na <sub>2</sub> SO <sub>4</sub> aq.
F7640001	Asahipak ES-502C 7C	0.55	Polyvinyl alcohol	9	2,000	7.5 x 100	0.1 M Sodium phosphate buffer (pH4.4)

### Amino acid analysis column [Functional Group: Sulfo (Na<sup>+</sup>) ]

#### • Standard columns

Product Code	Product Name	Plate Number (TP/column)	Base Material	Particle Size (µm)	Column Size (mm) I.D. x Length	Shipping Solvent
F6354211	CXpak P-421S	≥ 3,500	Styrene divinylbenzene copolymer	6	4.6 x 150	H <sub>2</sub> O
F6700210	CXpak P-G	(guard column)	Styrene divinylbenzene copolymer	6	4.6 x 10	H <sub>2</sub> O

### Proteins in human serum

Sample : Human serum 0.5 %, 200  $\mu$ L

1. IgG
2. Transferrin
3. (Unknown)
4. Serum albumin

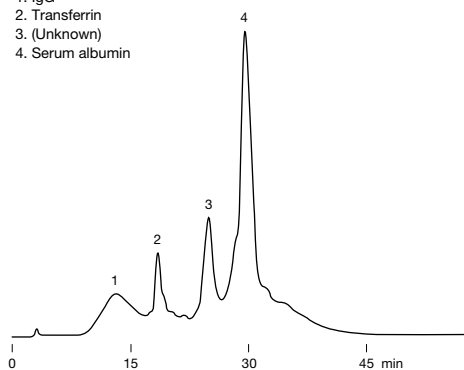

**Column** : Shodex IEC QA-825  
**Eluent** : (A); 20 mM Tris-HCl buffer (pH8.6)  
 (B); (A) + 0.5 M NaCl  
 Linear gradient; 100 % (A) to 50 % (B), 60 min  
**Flow rate** : 1.0 mL/min  
**Detector** : UV (280 nm)  
**Column temp.** : Room temp.

### Effects of eluent pH on DEAE-825 analysis

pH6.0

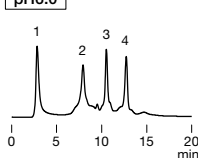

pH7.0

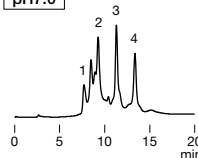

pH8.0

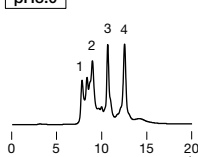

pH9.0

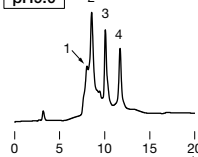

Sample : 100  $\mu$ L

1. Conalbumin 0.1 %
2. Transferrin 0.2 %
3. Ovalbumin 0.2 %
4. Trypsin inhibitor 0.2 %

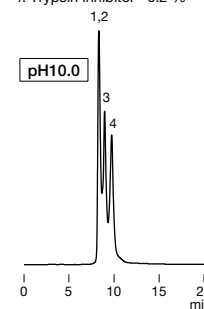

**Column** : Shodex IEC DEAE-825  
**Eluent** : (A); 20 mM Piperazine-HCl buffer (pH6.0), 20 mM Bis-Tris-HCl buffer (pH7.0)  
 20 mM Tris-HCl buffer (pH8.0), 20 mM Ethanolamine-HCl buffer (pH9.0)  
 20 mM 1,3-Diaminopropane-HCl buffer (pH10.0)  
 (B); (A) + 0.5 M NaCl  
 Linear gradient; (A) to (B), 20 min  
**Flow rate** : 1.0 mL/min  
**Detector** : UV (280 nm)  
**Column temp.** : 25  $^{\circ}$ C

### Gibberellin isomers

Sample : Gibberellin

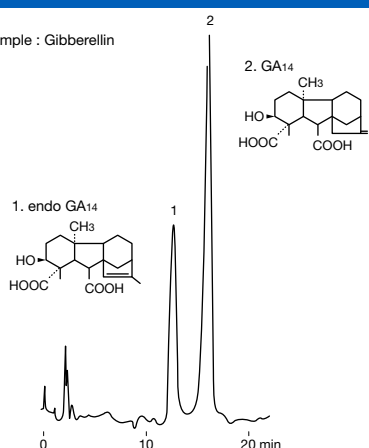

**Column** : Shodex Asahipak ES-502N 7C  
**Eluent** : CH<sub>3</sub>COOH/H<sub>2</sub>O/CH<sub>3</sub>OH = 0.1/0.4/99.5  
**Flow rate** : 1.5 mL/min  
**Detector** : UV (210 nm)  
**Column temp.** : 50  $^{\circ}$ C

Data provided by Prof. Yamaguchi,  
 Faculty of Agriculture, University of Tokyo.

### Protein separation using cation exchange columns

Sample : 90  $\mu$ L

1. Myoglobin
2. Trypsinogen
3. Ribonuclease A
4.  $\alpha$ -Chymotrypsinogen A
5. Cytochrome c
6. Lysozyme

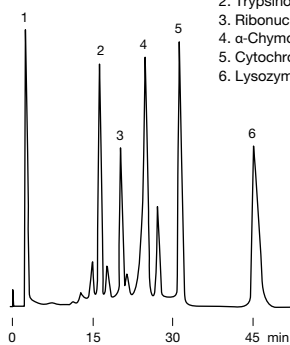

**Column** : Shodex IEC CM-825  
**Eluent** : (A); 20 mM Sodium phosphate buffer (pH7.0)  
 (B); (A) + 0.5 M NaCl  
 Linear gradient; (A) to (B), 60 min  
**Flow rate** : 1.0 mL/min  
**Detector** : UV (280 nm)  
**Column temp.** : Room temp.

### Ultra-rapid analysis of hemoglobins

Sample : 5  $\mu$ L

1. Trypsinogen 0.16 %
2.  $\alpha$ -Chymotrypsinogen A 0.08 %
3. Ribonuclease A 0.12 %
4. Cytochrome c 0.12 %
5. Lysozyme 0.06 %

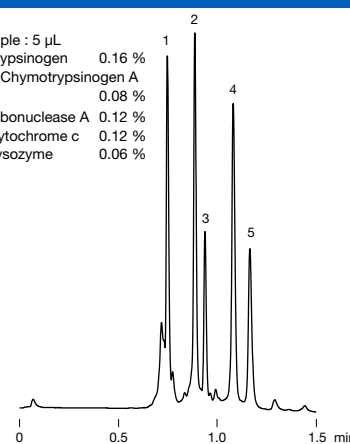

**Column** : Shodex IEC SP-FT 4A  
**Eluent** : (A); 20 mM MES buffer (pH5.6)  
 (B); (A) + 0.5 M Na<sub>2</sub>SO<sub>4</sub>  
 Linear gradient; (A) to (B), 2 min  
**Flow rate** : 1.7 mL/min  
**Detector** : UV (280 nm)  
**Column temp.** : 30  $^{\circ}$ C

### Paraquat and diquat

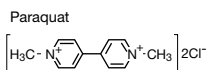

Sample : 20  $\mu$ L

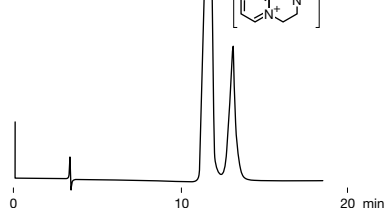
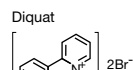
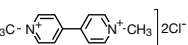

**Column** : Shodex Asahipak ES-502C 7C  
**Eluent** : 50 mM Sodium phosphate buffer (pH7.0) + 150 mM NaCl  
**Flow rate** : 1.0 mL/min  
**Detector** : UV (288 nm)  
**Column temp.** : 30  $^{\circ}$ C

### Standard amino acids

Sample : 0.1  $\mu$ M each, 100  $\mu$ L

1. Asp
2. Thr
3. Ser
4. Glu
5. Pro
6. Gly
7. Ala
8. Cystine
9. Val
10. Met
11. Ile
12. Leu
13. Tyr
14. Phe
15. Lys
16. NH<sub>3</sub>
17. His
18. Arg

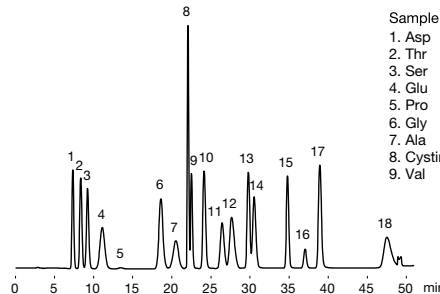

**Column** : Shodex CXPak P-421S  
**Eluent** : MCI BUFFER™ PH Kit (Mitsubishi Chemical Corporation)  
 Low pressure step gradient;  
 PH-1 (0 min), PH-2 (0.2 min), PH-3 (13.5 min), PH-4 (23.2 min), PH-RG (47.0 min)  
**Reagent** : Ninhydrin Coloring Solution Kit for HITACHI  
 (FUJIFILM Wako Pure Chemical Corporation)  
 R1:R2 = 50:50  
**Flow rate** : (Eluent) 0.5 mL/min  
 (Reagent) 0.35 mL/min  
**Detector** : VIS (570 nm)  
**Column Temp.** : 63  $^{\circ}$ C  
**Reaction Temp.** : 120  $^{\circ}$ C

# Chiral Separation Column

## Features

### CDBS-453

- Separates optical isomers by using their conformational compatibility differences
- Versatile column for chiral separation
- Fulfills USP-NF L45 requirements

### • Standard column

Product Code	Product Name	Functional Group	Particle Size (µm)	Column Size (mm) I.D. x Length	Shipping Solvent
F7146003	<b>ORpak CDBS-453</b>	β-Cyclodextrin derivative	3	<b>4.6 x 150</b>	0.05 % CH <sub>3</sub> COOH + 0.2 M NaCl aq./ CH <sub>3</sub> CN = 95/5

Base Material: Silica

## Aqueous SEC (GFC) Columns for Bionanoprotein Analysis and Preparative Use : Polymer-based

## Features

### UB New

- Suitable pore design for separating bionanoproteins such as viruses, virus-like particles (VLPs), and exosomes
- The uniform particles achieved both low back pressure and high separation efficiency
- High stability against basic solvents and other chemicals commonly used in bioprocessing

### • Standard columns

Product Code	Product Name	Plate Number (TP/column)	Particle Size (µm)	Target Molecular Size (nm)	Column Size (mm) I.D. x Length	Shipping Solvent
F6429301	<b>UB-50</b> <span style="color: blue;">New</span>	≥ 3,500	26	< 50	<b>8.0 x 300</b>	H <sub>2</sub> O
F6429302	<b>UB-100</b> <span style="color: blue;">New</span>	≥ 3,500	27	> 50	<b>8.0 x 300</b>	H <sub>2</sub> O

Base Material: Polyhydroxymethacrylate

## Pretreatment Column for Column Switching Method

## Features

### GF-4A

- High protein removal rate
- Removes surfactants well but is not suitable for trapping hydrophilic substances

### • Column for column switching method

Product Code	Product Name	Particle Size (µm)	Pore Size (Å)	Column Size (mm) I.D. x Length	Shipping Solvent
F8700015	<b>MSpak GF-4A</b>	9	400	<b>4.6 x 10</b>	H <sub>2</sub> O

Base Material: Polyvinyl alcohol

## GPC Clean-up Columns

## Features

### EV

- Suitable for fractionation of residual pesticides in foods
- EV-2000 AC is used in Shoku-An No. 0124001 (January 24th, 2005, Japan) of the Pharmaceutical and Food Safety Bureau, MHLW, Section 2 "Simultaneous GC/MS (LC/MS) Analyses of Agricultural Chemicals in Livestock and Marine Products".
- EV2000AC-12F is used in Shoku-An No. 0226 (February 26th, 2015, Japan) of the Pharmaceutical and Food Safety Bureau, MHLW, Section 2 "LC/MS Analyses of Agricultural Chemicals in Livestock and Marine Products".

### • GPC clean-up columns for residual pesticides in foods, etc.

Product Code	Product Name	Particle Size (µm)	Pore Size (Å)	Column Size (mm) I.D. x Length	Shipping Solvent
F6090006	<b>CLNpak EV2000AC-12F</b>	16	30	<b>12.0 x 300</b>	Acetone/Cyclohexane = 3/7
F6090007	<b>CLNpak EV-G AC12C</b>	16	(guard column)	<b>12.0 x 100</b>	Acetone/Cyclohexane = 3/7
F6090003	<b>CLNpak EV-2000 AC</b>	16	30	<b>20.0 x 300</b>	Acetone/Cyclohexane = 3/7
F6090004	<b>CLNpak EV-G AC</b>	16	(guard column)	<b>20.0 x 100</b>	Acetone/Cyclohexane = 3/7
F6090001	<b>CLNpak EV-2000</b>	16	30	<b>20.0 x 300</b>	Ethylacetate/Cyclohexane = 3/7
F6090002	<b>CLNpak EV-G</b>	16	(guard column)	<b>20.0 x 100</b>	Ethylacetate/Cyclohexane = 3/7
F6090005	<b>CLNpak EV-200</b>	16	30	<b>2.0 x 150</b>	Ethylacetate/Cyclohexane = 3/7

Base Material: Styrene divinylbenzene copolymer

### Chiral separation of epinephrine

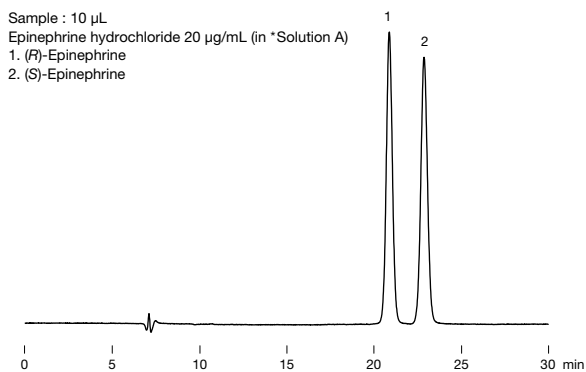

**Column** : Shodex ORpak CDBS-453  
**Eluent** : \*Solution A/CH<sub>3</sub>CN = 99/1  
**Flow rate** : 0.3 mL/min  
**Detector** : UV (280 nm)  
**Column temp.** : 25 °C

\*Solution A : 0.75 g/L Ammonium acetate aqueous solution adjusted to pH4.0 with Glacial acetic acid

### Impurity analysis of lamivudine according to USP-NF method

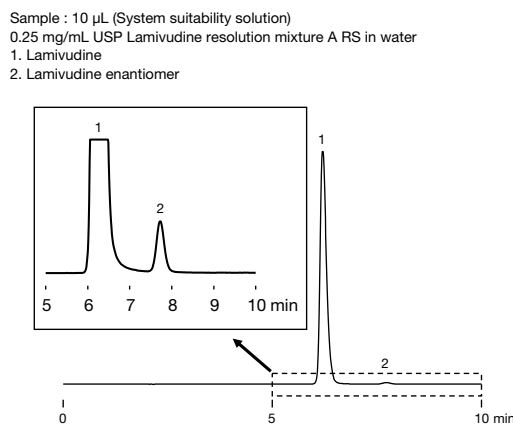

**Column** : Shodex ORpak CDBS-453  
**Eluent** : Methanol and \*Buffer (5 : 95)  
\*Buffer: 7.7 g/L of Ammonium acetate in water  
**Flow rate** : 1.0 mL/min  
**Detector** : UV (270 nm)  
**Column temp.** : 25 °C

### Separation features of UB series

The UB series particle pores are designed to target bionano-range product analysis. It separates high molecular weight impurities such as aggregates of bionanoproducts and low molecular weight impurities. UB-50 is suitable for separation and purification of targets below 50 nm, and UB-100 is suitable for larger size targets above 50 nm.

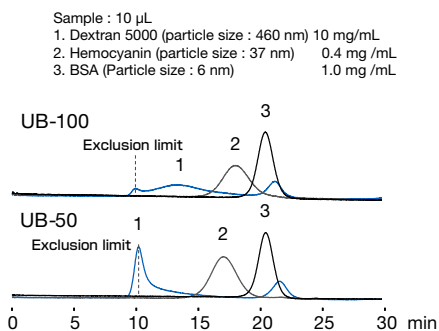

**Column** : Shodex UB-100, UB-50 (8.0 mm I.D. x 300 mm each)  
**Eluent** : 50 mM Sodium phosphate buffer (pH 7.0) + 0.3 M NaCl  
**Flow rate** : 0.6 mL/min  
**Detector** : UV (280 nm)  
**Column temp.** : 25 °C

### Exosome

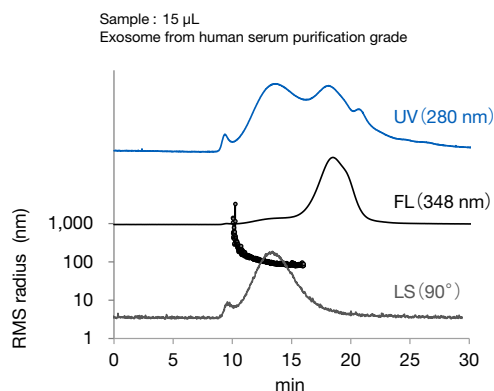

**Column** : Shodex UB-100 (8.0 mm I.D. x 300 mm)  
**Eluent** : PBS (-)  
**Flow rate** : 0.6 mL/min  
**Detector** : UV (280 nm) (small cell volume),  
Fluorescence (Ex. 280 nm, Em. 348 nm),  
MALS (Multi angle light scattering)  
**Column temp.** : Room temp.

### Sample preparation outline for simultaneous GC/MS and LC/MS analysis of agricultural chemicals in livestock and marine products

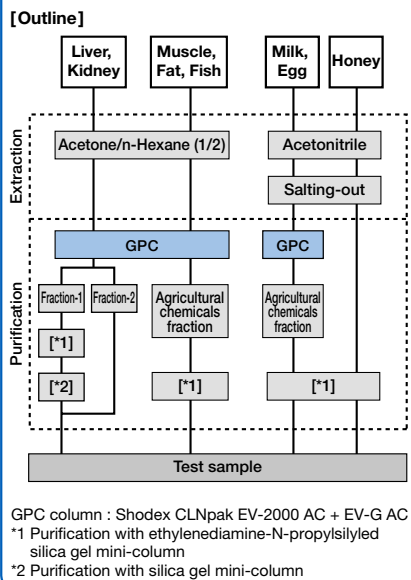

### Fractionation of agricultural chemicals using EV-2000 AC

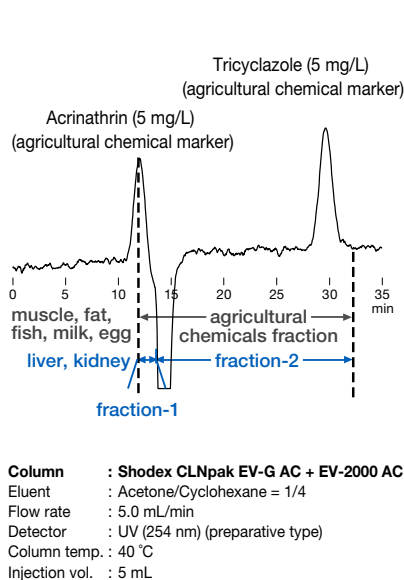

### GPC clean-up of fatty tuna and beef tallow

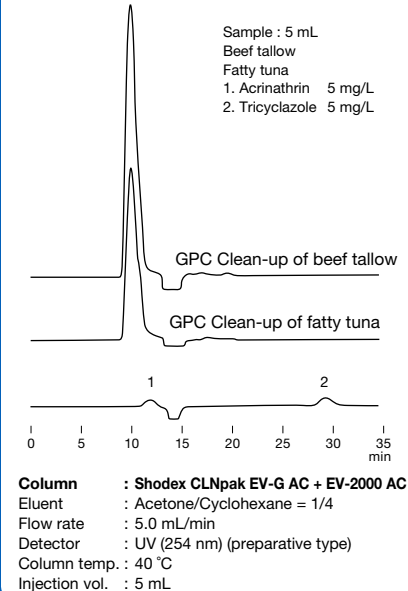

# Solvent Replacement Method for Organic SEC (GPC) Columns

Size exclusion chromatography (SEC) is a chromatography that separates the analytes based on the size of sample (polymer) molecules. The samples are generally prepared in a solvent that dissolves the target polymer well. Therefore, some target polymers may be dissolved in a solvent different from the shipping solution of SEC columns. In such cases, the column solvent needs to be replaced with the solvent to be used.

Shodex offers several SEC column series such as Asahipak GF series and OHPak series. Here, the GPC series, organic SEC (GPC) columns, are used as an example to explain the solvent replacement method.

Please consider this page as a general guideline and make sure to read the column-specific operation manual before replacing the solvents in your columns.

## ■ Before Starting: Check List

Incorrect solvent replacement method may damage the column. Please make sure to check the followings before replacing the solvents (the details follow after the list).

1. Applicable Solvents
2. Solvent Miscibility
3. Solvent Boiling Point
4. Column Specifications (maximum allowable pressure, flow rate, column volume, maximum temperature)
5. Setting the Pump Limiter's Maximum Pressure
6. HPLC System's Solvent Compatibility

## ■ Applicable Solvents

Check solvent replacement applicability of the column. Please refer to page 60: Solvent Replacement Applicability of Organic SEC (GPC) columns.

Please pay an extra attention as different pore-size columns even within the same column series may have different solvent replacement applicability. You may also check the solvent replacement applicability in the column-specific operation manual and Shodex website (<https://www.shodex.com/en/dc/06/03/09.html>).

## ■ Solvent Miscibility

Check miscibility/solubility of the desired new solvent and the solvent currently filled in the column. Please refer to Shodex website (<https://www.shodex.com/en/dc/06/0115.html>) for the miscibility of the solvents.

THF, chloroform, DMF, and HFIP are miscible with each other. On the other hand, sodium trifluoroacetate is soluble in HFIP but difficult to dissolve in THF. Thus, if HFIP with sodium trifluoroacetate and THF are mixed, sodium trifluoroacetate will precipitate. Precipitation of salt in the HPLC system or column may damage the system and/or the column. Therefore, it is important to check solubility of the salt in addition to checking the miscibility of solvents.

## ■ Solvent Boiling Point

The column pressure sometimes increases during the solvent replacement. Increasing the column oven temperature is an effective way of reducing the column pressure.

However, setting the column oven temperature higher than the boiling point of the solvent makes the solvent to generate air bubbles. Since the bubbles may affect the filling condition of the packing material, please pay an attention when increasing the column oven temperature.

## ■ Column Specifications

Please refer to the below table for the maximum pressure allowed per column and the recommended flow rate. Also, please check details of specifications described in the column-specific operation manual and Shodex website.

### < Column Specifications >

Product Series	Flow Rate (mL/min)	Maximum Pressure (MPa/column)	Maximum Temperature (°C)
GPC KF-800 series	0.5 - 1.0	3.5	60
GPC KD-800 series	0.5 - 1.0	3.5	60
GPC KF-400HQ series	0.3	7	45
GPC HK-400 series (for GPC HK-402)	0.3 - 1.0	25 (20)	60
GPC LF-804	1	3.5	60
GPC LF-604	0.5	3.5	60
GPC LF-404	0.3	3.5	60

Column volume of a column can be calculated using the below equation.

$$[\text{Column Volume}] = \left( \frac{[\text{Inner Diameter (I.D.)}]^2}{2} \right) \pi \times [\text{Length}]$$

The below table lists the column volumes of different-size columns.

#### < Column Volume (mL) >

Column Length (mm)	I.D. (mm)		
	4.6	6.0	8.0
10	0.2	-	-
50	-	-	2.5
100	-	-	5.0
150	2.5	4.2	-
250	4.2	-	12.6
300	-	-	15.1

#### ■ Setting the Pump Limiter's Maximum Pressure

The pressure applied to the entire HPLC system (system pressure) and the pressure applied to the column (column pressure) are influenced by eluent type, flow rate, and temperature. Thus, the column pressure may increase during the solvent replacement process. To prevent applying a pressure above the maximum allowable pressure of a column, use a pump limiter's maximum pressure setting.

The pressure displayed on the HPLC system is a sum of system pressure and column pressure. Therefore, generally the pump limiter's maximum pressure is set at "the sum of system and column's maximum allowable pressures". However, low flow rate used during the solvent replacement generates a negligible system pressure, thus using the column's maximum allowable pressure as the pump limiter's maximum pressure is a practical choice.

If multiple columns are used together, add maximum allowable pressure of all columns when setting the limit.

e.g. 1 When using one column with maximum allowable pressure = 3.5 MPa.

➔ Set the pump limiter's maximum pressure at 3.5 MPa.

e.g. 2 When using two columns with both maximum allowable pressures = 3.5 MPa.

➔ Set the pump limiter's maximum pressure at 7.0 MPa.

#### ■ HPLC System's Solvent Compatibility

Some materials used in HPLC system may have low chemical compatibility to organic solvents to be used in SEC analysis. To avoid damaging the HPLC system, please make sure that the chosen solvent is applicable for all HPLC system parts that have contact with the solvent.

Please note that there are tubes and fittings made of various materials. Among them, stainless steel types are recommended because of their high durability against various organic solvents.

#### ■ Solvent Replacement Steps

1. Reduce the flow rate to the half of the regular flow rate and increase the column oven temperature while keep introducing the current solvent (the temperature required depends on the column and the solvent used).

2. Move to next step once the column temperature reaches to the set temperature.

Case 1. When replacing the current solvent with a miscible solvent.

First introduce about 3 - 5 column volumes of an intermediate solvent (current solvent : new solvent = 1:1 mixture). Then, introduce another 3 - 5 column volumes of 100 % new solvent.

e.g. To replace THF to chloroform in KF-803 (8.0 mm I.D., 300 mm L)

First introduce 45 - 75 mL of an intermediate solvent (THF : chloroform = 1:1 mixture). Then, introduce 45 - 75 mL of 100 % chloroform.

Case 2. When replacing the current solvent with a solvent with low miscibility/solubility to the current solvent.

First introduce about 3 - 5 column volumes of a solvent that is miscible/soluble to both solvents. Then, follow the steps in Case 1.

e.g. To replace DMF with LiBr to THF in KD-806M (8.0 mm I.D., 300 mm L)

First introduce 45 - 75 mL of intermediate solvent 1 (DMF) to wash-out LiBr. Then, introduce 45 - 75 mL of intermediate solvent 2 (DMF : THF = 1: 1 mixture), followed by 45 - 75 mL of 100 % THF.

3. Set the flow rate and the temperature to the desired. Start the analysis once a stable baseline is obtained.

#### ■ Additional Recommendations

Frequent eluent replacement may damage the column, and thus not recommended.

If analyses using different eluents are frequently expected, it is recommended to have dedicated columns for each solvent.

# Column Cleaning

Problems in peak shapes and elution timing changes or elevated column pressure etc. are often caused by insoluble or adsorbing components present in the eluent and reagents being deposited inside the column. These problems may be resolved by cleaning the column.

This section describes general signs of column deterioration and column cleaning procedures.

Please also read column-specific detailed cleaning procedures included in the product operation manual.

## ■ Typical signs of column deterioration

1. Elevated column pressure
2. Abnormal peak shapes (broadening, leading, tailing, and split peaks)
3. Change in retention time
4. Unstable baseline

## ■ Standard cleaning procedures

1. Insoluble components

Insoluble components that block the column inlet may be removed by reversing the flow direction, i.e., introducing the eluent from the column outlet, with flow rate at less than half of the recommended flow rate.

2. Adsorbing components

For an efficient cleaning, reverse the flow direction and reduce the flow rate at half of the recommended flow rate.

## ■ Cleaning solvent selection guide

Solvents capable of dissolving the adsorbed substances

Solvents with high eluting power (depends on separation mode)

**\*use only the solvents allowed in the operation manual**

## Methods

Reversed phase chromatography columns	Use a solvent with higher organic solvent concentration such as methanol, acetonitrile, or THF. (When using a mixture of buffer solution and organic solvent, make sure there is no precipitation of salt.)
Sugar analysis columns	<b>[Ligand exchange columns (SUGAR series) ]</b> To regenerate the detached counter ions. - Flush or inject aqueous salt solvent which contains the modified counter ion. <b>[Polymer-based amino columns (NH2P series and VG series) ]</b> Adsorption of acidic substances on the amino functional group. - Flush with solvents in the following sequence; water, 0.1 M NaOH (aq.), water, and the eluent.
Aqueous SEC (GFC) chromatography columns	Adsorption of ionic substances. - Use a solvent with higher salt concentration or solvent with different pH from the eluent. Adsorption of hydrophobic substances. - Use a solvent containing organic solvent. (When using a mixture of buffer solution and organic solvent, make sure there is no precipitation of salt.)
Ion exchange chromatography columns	Adsorption of ionic substances. - Use a solvent with higher salt concentration or solvent with different pH from the eluent. Adsorption of hydrophobic substances. - Use a solvent containing organic solvent. (When using a mixture of buffer solution and organic solvent, make sure there is no precipitation of salt.) Adsorption of protein. - Inject 1 - 2 mL of 0.1 M NaOH (aq.) or 30 % acetic acid (aq.) several times.

\*Recommended solvent volume to introduce is 5 to 10 times the column volume.

\*Pay attention to the column pressure elevation during column cleaning.

\*Column cleaning is limited and does not guarantee full recovery of the column to its original condition.



# General Precautions for Column Handling

To achieve the best column performance, please follow the below instructions.

## HPLC System Preparation

- Wash entire HPLC system prior to column installation, including all flow-lines and sample loop by switching the valve, and then replace the washing solution with the eluent to be used.
- If desired new eluent has low miscibility/solubility to the eluent of previous analysis, first use the eluent that is miscible/soluble to both eluents, and then replace it with the desired eluent.
  - \*If the eluent left in the HPLC system is not compatible with the column to be used, it may damage the column.
  - \*A drastic change in the eluent compositions may remove substances adsorbed on the HPLC system and they may enter and deteriorate the column.

## Column Installation

- Connect the column to HPLC system by following the "flow direction arrow" (➔) indicated on the column adhesive label. If guard column is used, position the guard column in front (before the inlet) of the analytical column.
- Make sure to insert the tubing all the way to the end fitting and secure it with the male nut. It is important that there is no extra space between the tubing and the column side of the end fitting. Presence of an extra space will let the sample to spread out and may result in wide peaks.
- Set the initial flow rate at less than half of the recommended flow rate and start the system. If the column is to be heated during the analysis, keep the low flow rate until the column temperature reaches to the set temperature, and then gradually increase the flow rate to the desired temperature.
  - \*Verify that there is no solvent leak. The solvent leak may cause electronic leakage, rust, and/or chemical injury.
  - \*Make sure not to let air bubbles enter the column while installing the column. The air bubbles may damage the column.
  - \*When restarting the system after column installation or after holding the eluent flow, start the system at less than half of the recommended flow rate. A rapid increase in pressure can damage the column.
  - \*If the column was heated during the analysis, lower the flow rate to less than half of the recommended flow rate at the end of analysis. Then, turn off the column oven to let the column temperature returns to room temperature before stopping the pump. This is to prevent creating an empty space in the column, which deteriorates the column. Since if the pump was stopped while the eluent inside the column is still hot, the eluent volume decreases and creates an empty space when the eluent temperature decreases.
  - \*It is recommended to set the pump limiter to avoid exceeding the maximum pressure.

## Solvent Exchange

- To replace the solvent, start the system at less than half of the recommended flow rate. Recommended solvent volume to introduce at each step is 3 to 5 times of the column volume.
- Check miscibility/solubility of the desired new solvent and the solvent currently filled in the column.
- When replacing with a solvent having low miscibility/solubility to the current solvent, first use a solvent that is miscible/soluble to both (new and current) eluents, and then replace it with the new solvent.
- When using a gradient method, changes in the eluent compositions may increase the column backpressure. Adjust the flow rate and column temperature so that the column backpressure remains below the usable maximum pressure throughout the analysis.

## Column Storage

- Remove the column from HPLC system after replacing the in-column solvent with the initial shipping solvent. Securely tighten the end caps and store the column at a location with stable temperature (a cool and dark space is recommended).
  - \*Never allow inside the column to dry. It can damage the column.

## Column Inspection

- Inspection method is described in the Certificate of Analysis (CoA).
- Theoretical Plate Number (N) and Asymmetry Factor (Fas) were calculated using the below equations.

### Theoretical Plate Number (N)

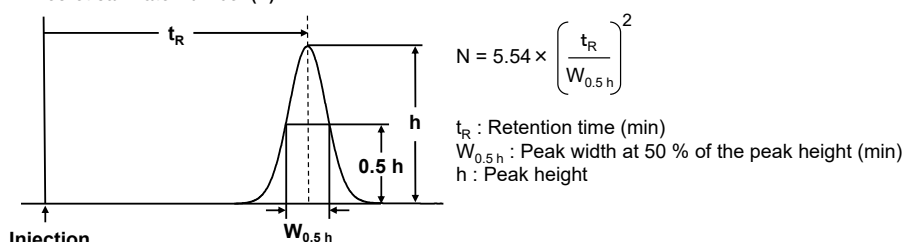

### Asymmetry Factor (Fas)

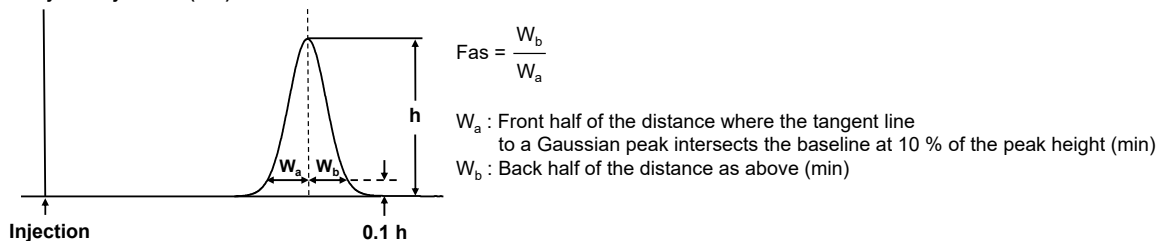

\*Plate count and Fas values change significantly depend on samples and/or analysis conditions being used. To check the initial column condition, please make sure to use the same sample and the analysis condition mentioned in the CoA.

## Additional Warnings

- Do not remove end fittings.
- Do not make a strong impact on the column. Do not drop or hit the column on a hard surface.
- Please follow a proper waste disposal method specified by your local regulations.

\*Read the operation manual before using the column.



# Troubleshooting

The troubleshooting below are typical examples.  
The cause or solution to the problem may be other than those listed below.

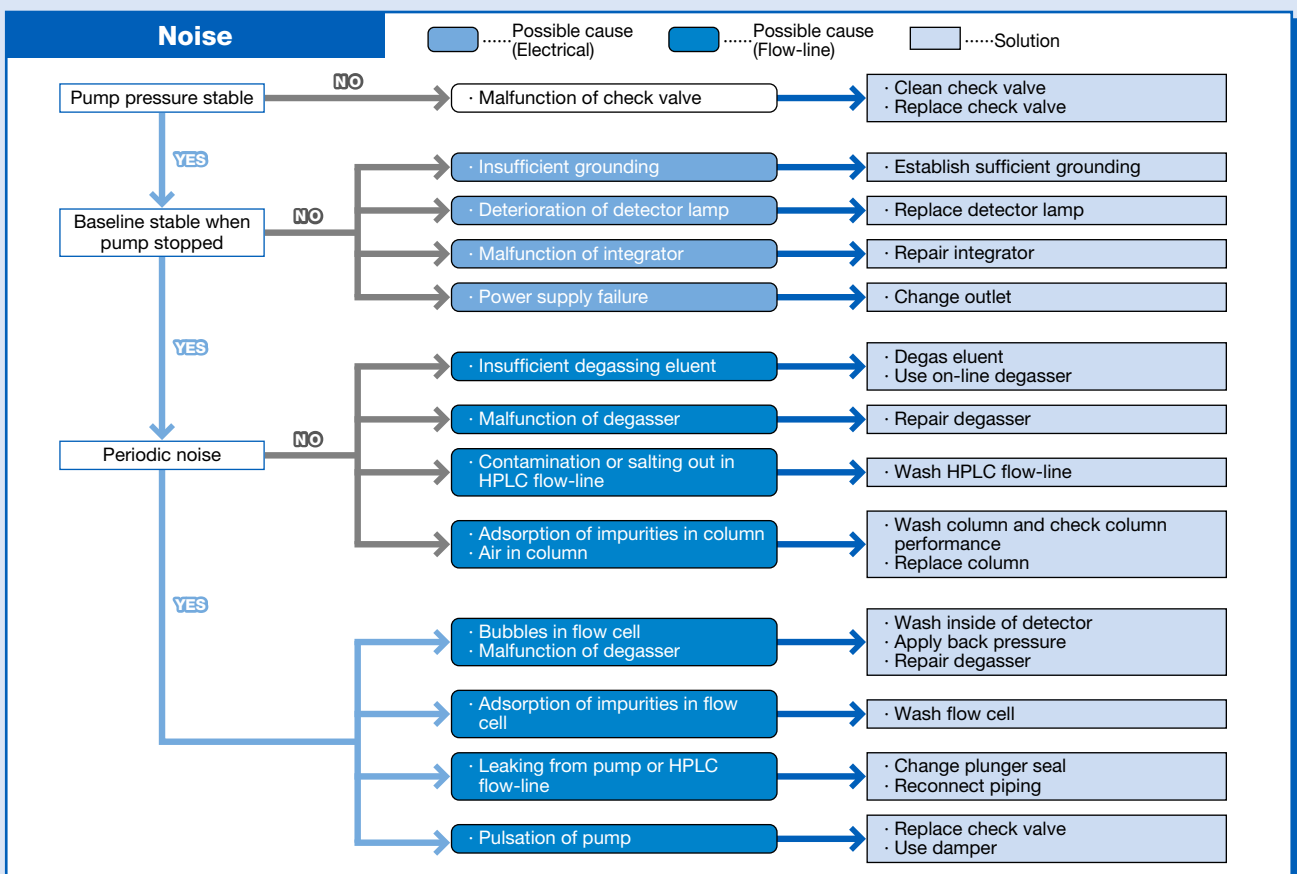
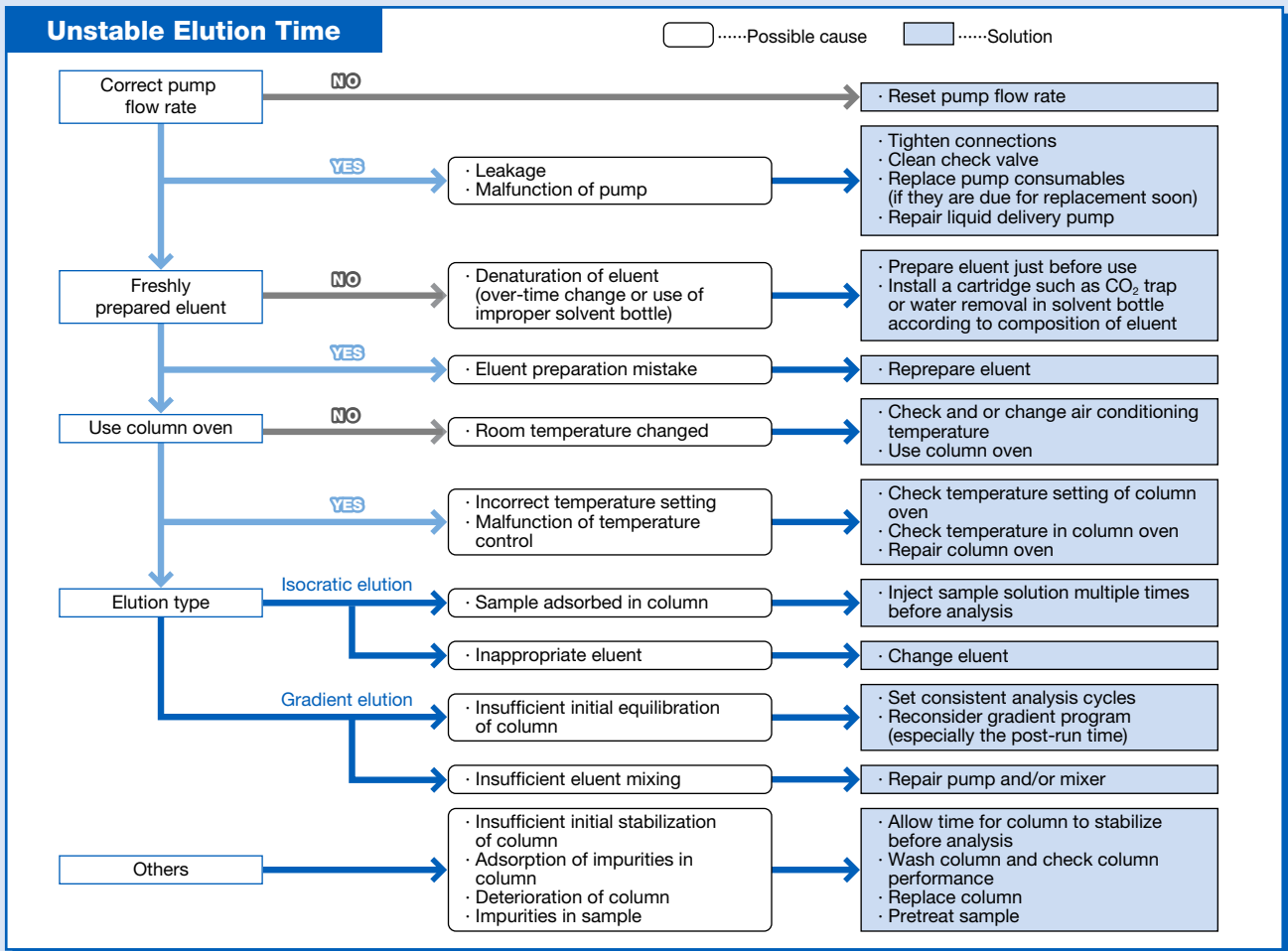

### Abnormal Peak Shapes

○ .....Possible cause    □ .....Solution

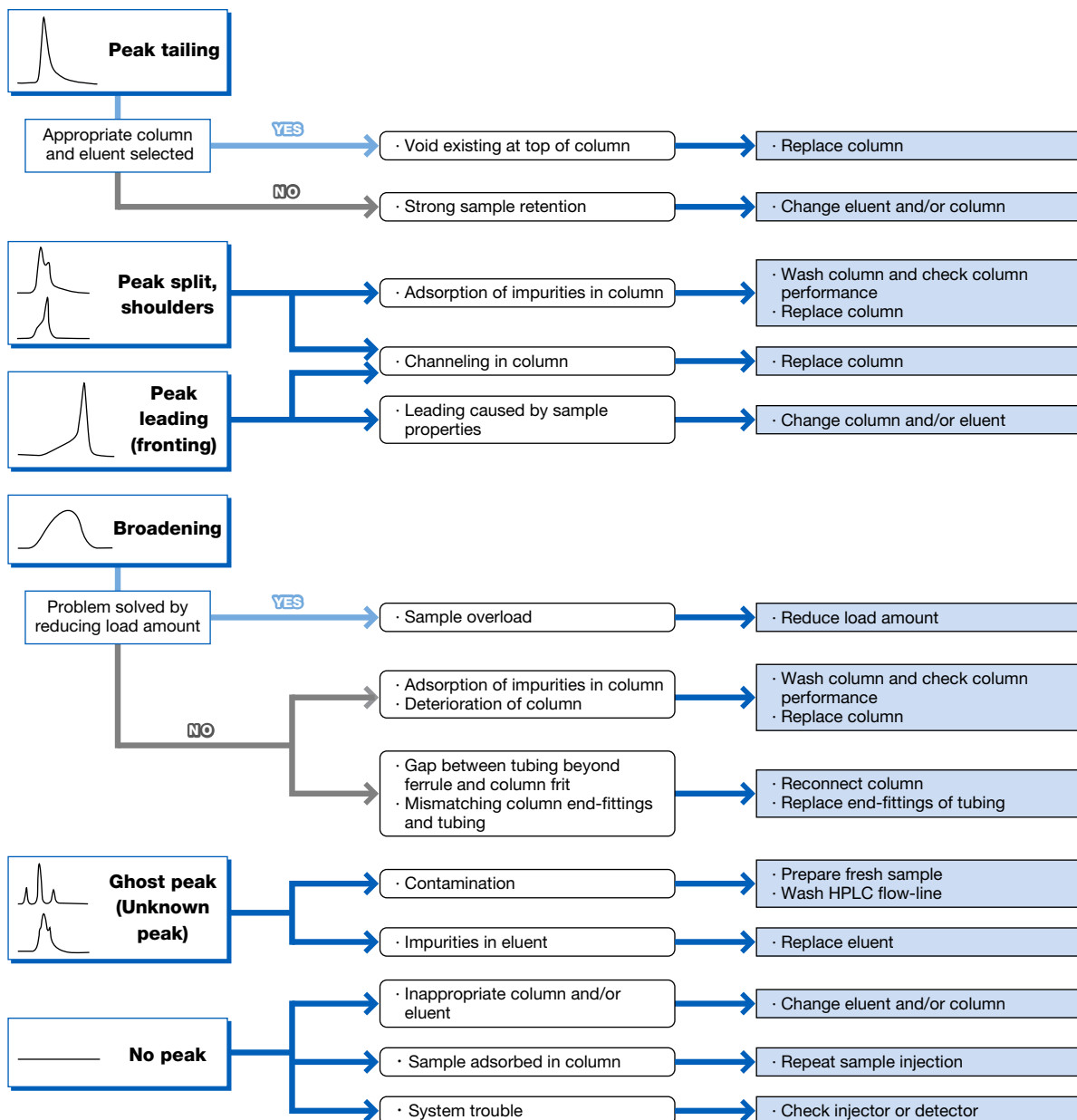

### Unstable Baseline

○ .....Possible cause    □ .....Solution

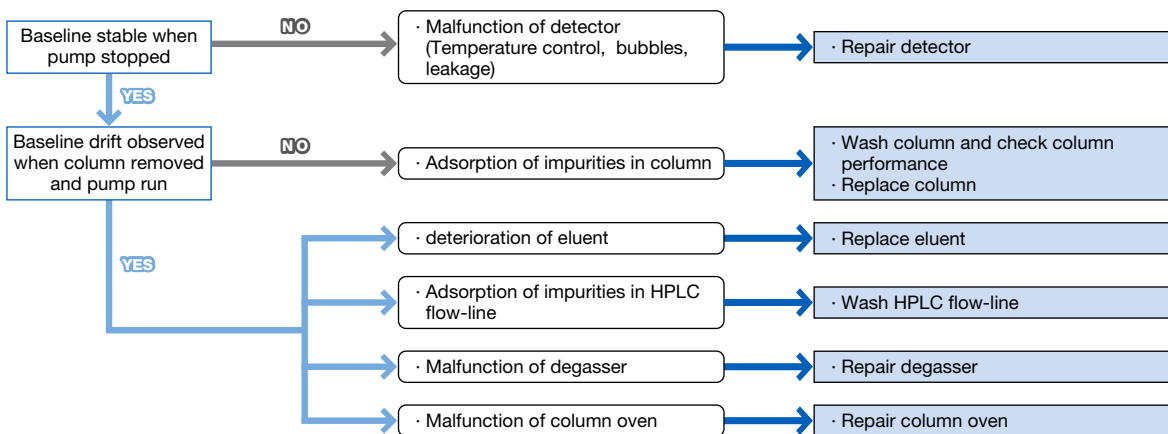

Note: If you are using a guard column, remove the guard column and run the analysis again using only the analytical column to see if the problem is resolved. If so, wash and/or replace the guard column.

# USP-NF Column List

No.	Packing Material	Corresponding Column	Page
L1	Octadecyl silane chemically bonded to porous or non-porous silica or ceramic micro-particles or superficially porous particles, 1.5 to 10 µm in diameter, or a monolithic rod.	Silica C18M 4D, C18M 4E	24
		C18U 2B, C18U 2D	24
L17	Strong cation-exchange resin consisting of sulfonated cross-linked styrene-divinylbenzene copolymer in the hydrogen form, 6 to 12 µm in diameter.	SUGAR SH1011, SH1011 8C	30
		SUGAR SH1821	30
		RSpak KC-811, KC-811 6E	30
L19	Strong cation-exchange resin consisting of sulfonated cross-linked styrene-divinylbenzene copolymer in the calcium form, 5 - 15 µm in diameter.	SUGAR SC1011	26
		SUGAR SC1211	26
		EP SC1011-7F	27
		USPpak MN-431	27
L20	Dihydroxypropane groups chemically bonded to porous silica or hybrid particles, 1.5 to 10 µm in diameter, or a monolithic silica rod.	PROTEIN KW-800 series	36
		KW400 series	36
		PROTEIN LW-803	37
		PROTEIN LW-403 4D	37
L21	A rigid, spherical styrene-divinylbenzene copolymer, 3 to 30 µm in diameter.	RSpak DS-613, DS-413	16
		GPC KF-800 series, KD-800 series, KF-400HQ series, HK-400 series, LF series	48, 50, 52, 54, 56
L22	A cation-exchange resin made of porous polystyrene gel with sulfonic acid groups, 5 - 15 µm in diameter.	SUGAR SC1011	26
		SUGAR SP0810, SP0810 8C	26
		SUGAR KS-800 series	26
		RSspak DC-613	26
		SUGAR SZ5532	26
		SUGAR SC1211	26
		EP SC1011-7F	27
		USPpak MN-431	27
		SUGAR SH1011, SH1011 8C	30
		SUGAR SH1821	30
RSpak KC-811, KC-811 6E	30		
L23	An anion-exchange resin made of porous polymethacrylate or polyacrylate gel with quaternary ammonium groups, 7-12 µm in size.	IC I-524A	32
		IEC QA-825	62
L25	Packing having the capacity to separate compounds with a molecular weight range from 100-5000 (as determined by polyethylene oxide), applied to neutral, anionic, and cationic water-soluble polymers. A polymethacrylate resin base, cross-linked with polyhydroxylated ether (surface contained some residual carboxyl functional groups) was found suitable.	OHpak SB-802 HQ	40
		OHpak SB-802.5 HQ	40
		OHpak LB-802.5	41
L33	Packing having the capacity to separate dextrans by molecular size over a range of 4,000 to 500,000 Da. It is spherical, silica-based, and processed to provide pH stability.	PROTEIN KW-800 series	36
		KW400 series	36
		PROTEIN LW-803, LW-403 4D	37
L34	Strong cation-exchange resin consisting of sulfonated cross-linked styrene-divinylbenzene copolymer in the lead form, 7 to 9 µm in diameter.	SUGAR SP0810, SP0810 8C	26
L37	Packing having the capacity to separate proteins by molecular size over a range of 2,000 to 40,000 Da. It is a polymethacrylate gel.	OHpak SB-803 HQ	40
		OHpak LB-803	41
L38	A methacrylate-based size-exclusion packing for water-soluble samples.	OHpak SB-800 HQ series	40
		OHpak LB-800 series	41
L39	A hydrophilic polyhydroxymethacrylate gel of totally porous spherical resin.	ODP2 HP series	12
		RSpak DM-614	16
		OHpak SB-800 HQ series	40
		OHpak LB-800 series	41
L45	Beta cyclodextrin, R,S-hydroxypropyl ether derivative, bonded to porous silica particles, 3 to 10 µm in diameter.	ORpak CDBS-453	64
L58	Strong cation-exchange resin consisting of sulfonated cross-linked styrene-divinylbenzene copolymer in the sodium form, about 6 to 30 µm in diameter.	SUGAR KS-800 series	26
		RSspak DC-613	26
		CXpak P-421S	62
L59	Packing for the size-exclusion separations of proteins (separation by molecular weight) over the range of 5 to 7000 kDa. The packing is spherical 1.5 - 10 µm, silica or hybrid packing with a hydrophilic coating.	PROTEIN KW-800 series	36
		KW400 series	36
		PROTEIN LW-803, LW-403 4D	37
L67	Porous vinyl alcohol copolymer with a C18 alkyl group attached to the hydroxyl group of the polymer, 2 to 10 µm in diameter.	Asahipak ODP-50 series	14
L71	A rigid, spherical polymethacrylate, 4 to 6 µm in diameter.	RSpak DE-613, DE-413, DE-213	16
L76	Silica based, weak cation-exchange material, 5 µm in diameter. Substrate is surface polymerized polybutadiene-maleic acid to provide carboxylic acid functionalities. Capacity not less than 29 µEq/column.	IC YK-421	33
L82	Polyamine chemically bonded to cross-linked polyvinyl alcohol polymer, 5 µm in diameter.	Asahipak NH2P-50 series, NH2P-40 series	22
L89	Packing having the capacity to separate compounds with a molecular weight range from 100 - 3000 (as determined by polyethylene oxide), applied to neutral and anionic water-soluble polymers. A polymethacrylate resin base, cross-linked with polyhydroxylated ether (surface contains some residual cationic functional groups).	OHpak SB-802 HQ, SB-802.5 HQ	40
		OHpak LB-802.5	41
L125	Polyvinyl alcohol polymer gel weak cation-exchange packing material, 5 µm porous particles. The surface is polymerized with polybutadiene-maleic acid to provide carboxylic acid functionalities. The Capacity is not less than 1 mEq/column.	IC YS-50	33

Note: Please check USP's "Chromatographic Database" for the latest information.

# Index by Product Name

Columns are listed in alphabetical order without their series names.

[Series name]

Asahipak	CLNpak	CXpak	EP	GPC	HILICpak	IC	IEC	MSpak
OHpak	ORpak	PROTEIN	RSpak	Silica	STANDARD	SUGAR	USPpak	

<b>C</b>		<b>I</b>		<b>P</b>	
C18M 4D, C18M 4E.....	24	I-524A.....	32	P-421S .....	62
C18U 2B, C18U 2D .....	24			P-82 .....	61
C4P-50 4D.....	14	<b>J</b>		<b>Q</b>	
CDBS-453 .....	64	JJ-50 2D .....	16	QA-825 .....	62
CM-825 .....	62	<b>K</b>		<b>S</b>	
<b>D</b>		K-2000 .....	59	SB-2000.....	40
DC-613 .....	26	K-5000 .....	59	SB-800 HQ .....	40
DE-213, DE-413, DE-613 .....	16	KC-811, KC-811 6E.....	30	SC1011 .....	26
DEAE-825 .....	62	KD-800 .....	50	SC1011-7F .....	27
DM-614 .....	16	KF-2000.....	59	SC1211 .....	26
DS-413, DS-613 .....	16	KF-5000.....	59	SH1011, SH1011 8C .....	30
<b>E</b>		KF-400HQ.....	52	SH1821 .....	30
ES-502C 7C .....	62	KF-800 .....	48	SH-75.....	61
ES-502N 7C .....	62	KF-800D.....	48	SI-35 2B.....	33
EV-200 .....	64	KS-800 .....	26	SI-35 4D.....	32
EV-2000 .....	64	KW400 .....	36	SI-36 4D.....	33
<b>F</b>		KW-800 .....	36	SI-37 4D.....	33
FP-2002 .....	58	<b>L</b>		SI-50 4E.....	32
<b>G</b>		LB-800 .....	41	SI-52 4E.....	32
GF-210 HQ .....	46	LF-404, LF-604, LF-804 .....	56	SI-90 4E.....	32
GF-310 4D, GF-310 HQ .....	46	LW-403 4D .....	37	SL-105 .....	61
GF-4A.....	64	LW-803 .....	37	SM-105 .....	61
GF-510 HQ .....	46	<b>M</b>		SP0810, SP0810 8C .....	26
GF-7M HQ.....	46	M-75 .....	61	SP-825 .....	62
GS-220 20G, GS-220 HQ .....	44	MN-431 .....	27	SP-FT 4A .....	62
GS-310 20G .....	46	<b>N</b>		SZ5532 .....	26
GS-320 20G, GS-320 HQ .....	44	NH2P .....	22	<b>V</b>	
GS-510 20G .....	46	NI-424 .....	32	VC-50 2D .....	18
<b>H</b>		NN-814 .....	16	VG-25.....	18
H-2000 .....	59	<b>O</b>		VG-50.....	18
HK-400 .....	54	ODP2 HP .....	12	VN-50.....	19
		ODP-50 .....	14	VT-50 2D .....	18
		<b>Y</b>		YK-421 .....	33
				YS-50 .....	33

# Index by Product Code

Product Code	Product Name	Page
F6021041	LF-804	56
F6021042	LF-604	56
F6021043	LF-404	56
F6025010	HK-401	54
F6025020	HK-402	54
F6025030	HK-403	54
F6025050	HK-405	54
F6025060	HK-406	54
F6026040	HK-404L	54
F6027030	KF-803L	48
F6027040	KF-804L	48
F6027050	KF-805L	48
F6027060	KF-806L	48
F6027070	KF-807L	48
F6028010	KF-801	48
F6028020	KF-802	48
F6028025	KF-802.5	48
F6028030	KF-803	48
F6028040	KF-804	48
F6028050	KF-805	48
F6028090	KF-806M	48
F6028111	KF-401HQ	52
F6028112	KF-402HQ	52
F6028114	KF-402.5HQ	52
F6028116	KF-403HQ	52
F6028210	KD-801	50
F6028220	KD-802	50
F6028225	KD-802.5	50
F6028230	KD-803	50
F6028240	KD-804	50
F6028250	KD-805	50
F6028260	KD-806	50
F6028270	KD-807	50
F6028290	KD-806M	50
F6090001	EV-2000	64
F6090002	EV-G	64
F6090003	EV-2000 AC	64
F6090004	EV-G AC	64
F6090005	EV-200	64
F6090006	EV2000AC-12F	64
F6090007	EV-G AC12C	64
F6102001	H-2001	59
F6102002	H-2002	59
F6102003	H-2003	59
F6102004	H-2004	59
F6102005	H-2005	59
F6102006	H-2006	59

Product Code	Product Name	Page
F6102009	H-2006M	59
F6102025	H-2002.5	59
F6102301	K-2001	59
F6102303	K-2003	59
F6102304	K-2004	59
F6102305	K-2005	59
F6102306	K-2006	59
F6102309	K-2006M	59
F6102312	K-2002	59
F6102315	K-2002.5	59
F6102401	KF-2001	59
F6102402	KF-2002	59
F6102403	KF-2003	59
F6102404	KF-2004	59
F6102405	KF-2005	59
F6102406	KF-2006	59
F6102409	KF-2006M	59
F6102425	KF-2002.5	59
F6102520	FP-2002	58
F6108010	KF-5001	59
F6108020	KF-5002	59
F6108025	KF-5002.5	59
F6108030	KF-5003	59
F6108040	KF-5004	59
F6109010	K-5001	59
F6109020	K-5002	59
F6109025	K-5002.5	59
F6109030	K-5003	59
F6109040	K-5004	59
F6110002	CM-825	62
F6110011	QA-825	62
F6113100	SP-FT 4A	62
F6118250	SP-825	62
F6118255	DEAE-825	62
F6354211	P-421S	62
F6378010	KS-801	26
F6378020	KS-802	26
F6378025	KS-803	26
F6378030	KC-811	30
F6378033	KC-811 6E	30
F6378035	KS-804	26
F6378100	SH1011	30
F6378101	SH1821	30
F6378102	SC1011	26
F6378104	SH1011 8C	30
F6378105	SP0810	26
F6378106	SP0810 8C	26

Product Code	Product Name	Page
F6379230	MN-431	27
F6379300	SC1011-7F	27
F6429100	SB-802 HQ	40
F6429101	SB-802.5 HQ	40
F6429102	SB-803 HQ	40
F6429103	SB-804 HQ	40
F6429104	SB-805 HQ	40
F6429105	SB-806 HQ	40
F6429106	SB-806M HQ	40
F6429108	SB-807 HQ	40
F6429201	LB-803	41
F6429202	LB-806M	41
F6429203	LB-805	41
F6429204	LB-804	41
F6429205	LB-806	41
F6429206	LB-802.5	41
F6429301	UB-50	64
F6429302	UB-100	64
F6516011	SB-2002	40
F6516012	SB-2002.5	40
F6516013	SB-2003	40
F6516014	SB-2004	40
F6516015	SB-2005	40
F6516016	SB-2006	40
F6516017	SB-2006M	40
F6650040	C18M 4D	24
F6650041	C18M 4E	24
F6654011	C18U 2B	24
F6654012	C18U 2D	24
F6700010	KC-G 8B	30
F6700020	KS-G 6B	26
F6700030	KC-G 6B	30
F6700080	SH-G	30
F6700081	SP-G 6B	26
F6700090	SC-G 6B	26, 27
F6700100	HK-G filter	54
F6700110	SZ-G	26
F6700120	SC1211G 4A	26
F6700131	KW-G 6B	36
F6700132	KW400G-4A	36
F6700133	LW-G 6B	37
F6700134	LS-G 4J	37
F6700140	DS-G	16
F6700150	DE-G 4A	16
F6700151	DE-G 2A	16
F6700160	DM-G 4A	16
F6700170	DC-G 4A	26

Product Code	Product Name	Page
F6700200	HK-G	54
F6700210	P-G	62
F6700300	KF-G 4A	48, 52
F6700310	H-G 8B	59
F6700340	FP-G 8B	58
F6700400	IA-G	32
F6700406	KF-G 8B	59
F6700407	K-G 8B	59
F6700408	KF-G 20C	59
F6700409	K-G 20C	59
F6700411	KD-G 4A	50
F6700510	NN-G	16
F6700530	YS-G	33
F6709350	KF-800D	48
F6709430	SB-G 6B	40
F6709431	SB-807G	40
F6709434	LB-G 6B	41
F6709555	SB-G 8B	40
F6709608	YK-G	33
F6709616	NI-G	32
F6709620	SI-90G	32, 33
F6709621	LF-G	56
F6709625	SI-50G	32
F6709626	SI-92G	32
F6709627	SI-95G	32
F6709720	SI-2GF	33
F6709730	SI-2GF filter	33
F6710001	ODP-50G 6A	14
F6710003	C4P-50G 4A	14
F6710004	ODP-130G 7B	14
F6710016	NH2P-50G 4A	22
F6710017	NH2P-130G 7B	22
F6710018	GF-1G 7B	46
F6710019	GS-2G 7B	44
F6710020	GS-10G 7B	46
F6710021	GS-20G 7B	44
F6710022	ODP-50G 4A	14
F6710023	ODP-50 4B	14
F6710030	NH2P-50G 3A	22
F6711100	VG-50G 4A	18
F6711200	VG-50G 2A	18
F6711300	VT-50G 2A	18
F6711400	VN-50G 4A	19
F6711500	VN-50G 2A	19
F6711600	VC-50G 2A	18
F6711800	VG-25G 4A	18
F6711900	VG-25G 2A	18

Product Code	Product Name	Page
F6713000	NH2P-50G 2A	22
F6713001	ODP-50G 2A	14
F6714010	ODP2 HPG-4A	12
F6714011	ODP2 HPG-2A	12
F6714015	ODP2 HPG-7B	12
F6810034	GS-220 20G	44
F6810035	GS-320 20G	44
F6810038	GS-310 20G	46
F6810039	GS-510 20G	46
F6820001	ODP-50 10E	14
F6820035	ODP-90 20F	14
F6822001	ODP2 HP-10E	12
F6830001	NH2P-50 10E	22
F6830031	NH2P-90 20F	22
F6830100	VN-50 10E	19
F6989000	KW-802.5	36
F6989103	KW-803	36
F6989104	KW-804	36
F6989201	KW402.5-4F	36
F6989202	KW403-4F	36
F6989203	KW404-4F	36
F6989204	KW405-4F	36
F6989303	LW-803	37
F6989403	LW-403 4D	37
F6995240	I-524A	32
F6995243	NI-424	32
F6995244	SI-90 4E	32
F6995245	SI-50 4E	32
F6995260	SI-52 4E	32
F6995290	SI-35 4D	32
F6995291	SI-35 2B	33
F6999361	SI-36 4D	33
F6999371	SI-37 4D	33
F7001001	DS-613	16
F7001002	DM-614	16
F7001003	DC-613	26
F7001004	DE-613	16
F7001005	DE-413	16
F7001007	DE-213	16
F7001012	DS-413	16
F7001300	SZ5532	26
F7001400	SC1211	26
F7008140	NN-814	16
F7008220	JJ-50 2D	16
F7120012	YK-421	33
F7122000	YS-50	33
F7146003	CDBS-453	64

Product Code	Product Name	Page
F7600000	GF-210 HQ	46
F7600001	GF-310 HQ	46
F7600002	GF-510 HQ	46
F7600004	GF-7M HQ	46
F7600005	GS-220 HQ	44
F7600006	GS-320 HQ	44
F7600110	GF-310 4D	46
F7620001	ODP-50 6E	14
F7620002	ODP-50 6D	14
F7620003	ODP-50 4E	14
F7620004	ODP-50 4D	14
F7620008	C4P-50 4D	14
F7620009	ODP-50 2D	14
F7622001	ODP2 HP-4B	12
F7622002	ODP2 HP-4D	12
F7622003	ODP2 HP-4E	12
F7622004	ODP2 HP-2B	12
F7622005	ODP2 HP-2D	12
F7630001	NH2P-50 4E	22
F7630002	NH2P-50 4D	22
F7630005	NH2P-50 4B	22
F7630006	NH2P-50 2D	22
F7630007	NH2P-40 3E	22
F7630010	NH2P-40 2E	22
F7630100	VG-50 4E	18
F7630200	VG-50 4D	18
F7630300	VG-50 2D	18
F7630400	VT-50 2D	18
F7630500	VN-50 4D	19
F7630600	VN-50 2D	19
F7630700	VC-50 2D	18
F7630800	VN-50 1D	19
F7631000	VG-25 4D	18
F7631100	VG-25 2B	18
F7640001	ES-502C 7C	62
F7640002	ES-502N 7C	62
F8400000	P-82	61
F8601105	SL-105	61
F8602105	SM-105	61
F8603075	SH-75	61
F8604075	M-75	61
F8700015	GF-4A	64

# Shodex Support

Shodex Support is available worldwide in many languages.

Please check your local Shodex website.

## Resonac America, Inc.

Service Area	North America, Latin America
Languages Available in	English, French, Spanish and Portuguese
URL	<a href="https://www.shodexhplc.com">https://www.shodexhplc.com</a>

## Resonac Europe GmbH

Service Area	Europe, Africa, Middle East
Languages Available in	German and English
URL	<a href="https://www.shodex.de">https://www.shodex.de</a>

## Resonac Asia Pacific Pte. Ltd.

Service Area	Southeast Asia, India, Oceania
Languages Available in	English
URL	<a href="https://www.ap.resonac.com">https://www.ap.resonac.com</a>

## Shoko Korea Co., Ltd.

Service Area	Republic of Korea
Languages Available in	Korean
URL	<a href="https://www.shodex.com/kr">https://www.shodex.com/kr</a>

## Resonac Shodex (Shanghai) Co., Ltd.

Service Area	P.R.China
Languages Available in	Chinese
URL	<a href="https://www.shodex.com/cn">https://www.shodex.com/cn</a>

## Shoko Science Co., Ltd.

Service Area	Japan
Languages Available in	Japanese
URL	<a href="https://www.shodex.com/ja">https://www.shodex.com/ja</a>

## Resonac Corporation

Service Area	Other Area
Languages Available in	English
URL	<a href="https://www.shodex.com/en">https://www.shodex.com/en</a>



## Announcement of Paperless Product Operation Manuals and Certificate of Analysis

From January 2023, as a part of our environmental contribution, Shodex has started to provide digital versions of product operation manuals and certificate of analysis (CoA) instead of enclosing their printed versions in the products.

Digital versions are ready for those products provided without enclosed printed versions. Please make sure to download them from the Shodex website before use.

<https://www.shodex.com/download/>



### [Registered Trademarks]

The following names are registered trademarks of Resonac Corporation in below countries.

Registered Trademarks	Countries of Registration
Shodex	Australia, EU, India, Japan, P.R.China, Republic of Korea, Singapore, USA
SHODEX	Japan
Asahipak	EU, Japan, P.R.China, USA
CLNpak	Japan
HILICpak	India, Japan, P.R.China, Republic of Korea, USA
ODP	EU, Japan, USA
OHpak	EU, India, Japan, P.R.China, Republic of Korea, Singapore, USA
ORpak	Japan
Shodex HILICpak	EU, P.R.China
SUGAR	Japan



# Please contact a Shodex support office near you.

Support office		
North America Latin America	<b>Resonac America, Inc.</b> 420 Lexington Avenue Suite 820 New York, NY 10170 USA TEL: +1 212 370 0033 E-mail : support@shodexhplc.com URL: <a href="https://www.shodexhplc.com">https://www.shodexhplc.com</a>	
Europe Africa Middle East	<b>Resonac Europe GmbH</b> Konrad-Zuse-Platz 3, 81829 Munich, Germany TEL: +49 89 93 99 62 41 E-mail: info@shodex.de URL: <a href="https://www.shodex.de">https://www.shodex.de</a>	
Southeast Asia India Oceania	<b>Resonac Asia Pacific Pte. Ltd.</b> 4 Shenton Way #16-02/06, SGX Centre 2, Singapore 068807 TEL: +65 6836 6988 E-mail: reap_admi@resonac.com URL: <a href="https://www.ap.resonac.com">https://www.ap.resonac.com</a>	
Republic of Korea	<b>한국쇼크츠주식회사 (Shoko Korea Co., Ltd.)</b> #322, Chungjeong Rizion, 27, Seosomun-ro, Seodaemun-gu, Seoul, Republic of Korea 03741 TEL: +82 (0)2-784-5111 E-mail: shoko.korea@shokokorea.com URL: <a href="https://www.shodex.com/kr">https://www.shodex.com/kr</a>	
P.R.China	<b>力森诺科科学仪器 (上海) 有限公司 (Resonac Shodex (Shanghai) Co., Ltd.)</b> 19F, No.668, Xin Zha Road, Jing An, Shanghai, 200041, P.R.China TEL: +86 (0)21-62176111 E-mail: Shodex_sales_cn@resonac.com URL: <a href="https://www.shodex.com/cn">https://www.shodex.com/cn</a>	
Japan	<b>Shoko Science Co., Ltd.</b> 1-3-3, Azamino-Minami, Aoba-ku, Yokohama, 225-0012, Japan TEL: +81-(0)45-913-6688 E-mail: shodex.tokyo@shoko.co.jp URL: <a href="https://www.shodex.com/ja">https://www.shodex.com/ja</a>	
Other Area	<b>Resonac Corporation</b> Tokyo Shiodome Bldg., 1-9-1, Higashi-Shimbashi, Minato-ku, Tokyo 105-7325, Japan TEL: +81-(0)3-6263-8112 E-mail: Shodex_sales_jpn@resonac.com URL: <a href="https://www.shodex.com/en">https://www.shodex.com/en</a>	

Manufactured by

**RESONAC**

## Resonac Corporation

Shodex (Separation & HPLC) Group  
Tokyo Shiodome Bldg., 1-9-1, Higashi-Shimbashi, Minato-ku, Tokyo 105-7325, Japan  
TEL: +81-(0)3-6263-8112